

Service and Troubleshooting

*VZC20 INVERTER HEAT PUMP CONDENSER UNITS WITH R-410A REFRIGERANT BLOWERS, COILS, & ACCESSORIES

Pride and workmanship go into every product to provide our customers with quality products. It is possible, however, that during its lifetime a product may require service. Products should be serviced only by a qualified service technician who is familiar with the safety procedures required in the repair and who is equipped with the proper tools, parts, testing instruments and the appropriate service manual. **REVIEW ALL SERVICE INFORMATION IN THE APPROPRIATE SERVICE MANUAL BEFORE BEGINNING REPAIRS.**

For service information related to the Bluetooth® Shared Data Loader BTSDL01 referenced in this manual, please refer to the installation instructions for the BTSDL01 at www.coolcloudhvac.com/loaderuserguide.

TABLE OF CONTENTS

IMPORTANT INFORMATION.....	2
PRODUCT IDENTIFICATION	4
SYSTEM OPERATION.....	6
SERVICING.....	14
CHECKING VOLTAGE	14
CHECKING WIRING	14
CHECKNG THERMOSTAT, WIRING	14
THERMOSTAT AND WIRING.....	14
THERMOSTAT COMFORTBRIDGE™ SYSTEM	14
COMFORTBRIDGE™ SYSTEM WIRING	14
CHECKING TRANSFORMER AND CONTROL CIRCUIT	15
CHECKING HIGH PRESSURE SWITCH	15
CHECKING INDOOR AND OUTDOOR HI/LOW PRESSURE SENSOR.....	15
CHECKING COMPRESSOR.....	16
COMPRESSOR WINDING INSULATION TEST	16
GROUND TEST	17
TESTING CRANKCASE HEATER (5 TON ONLY)....	17
TESTING TEMPERATURE SENSORS AND EEV COIL RESISTANCE.....	17
TESTING EEV COIL RESISTANCE	18
TESTING REVERSING VALVE.....	18
MBVC**00AA-1 HEATER CONTROL.....	18
AVPEC* HEATER CONTROL.....	19
REFRIGERATION REPAIR PRACTICE	20
LEAK TESTING (NITROGEN OR NITROGEN-TRACED)	21
EVACUATION	21
CHARGING	22



WARNING

ONLY PERSONNEL THAT HAVE BEEN TRAINED TO INSTALL, ADJUST, SERVICE OR REPAIR (HEREINAFTER, "SERVICE") THE EQUIPMENT SPECIFIED IN THIS MANUAL SHOULD SERVICE THE EQUIPMENT. THE MANUFACTURER WILL NOT BE RESPONSIBLE FOR ANY INJURY OR PROPERTY DAMAGE ARISING FROM IMPROPER SERVICE OR SERVICE PROCEDURES. IF YOU SERVICE THIS UNIT, YOU ASSUME RESPONSIBILITY FOR ANY INJURY OR PROPERTY DAMAGE WHICH MAY RESULT. IN ADDITION, IN JURISDICTIONS THAT REQUIRE ONE OR MORE LICENSES TO SERVICE THE EQUIPMENT SPECIFIED IN THIS MANUAL, ONLY LICENSED PERSONNEL SHOULD SERVICE THE EQUIPMENT. IMPROPER INSTALLATION, ADJUSTMENT, SERVICING OR REPAIR OF THE EQUIPMENT SPECIFIED IN THIS MANUAL, OR ATTEMPTING TO INSTALL, ADJUST, SERVICE OR REPAIR THE EQUIPMENT SPECIFIED IN THIS MANUAL WITHOUT PROPER TRAINING MAY RESULT IN PRODUCT DAMAGE, PROPERTY DAMAGE, PERSONAL INJURY OR DEATH.

RS6215002r11
March 2021

Copyright © 2015-2017, 2020-2021 Goodman Manufacturing Company, L.P.

Amana is a registered trademark of Maytag Corporation or its related companies and is used under license. All rights reserved.

IMPORTANT INFORMATION

CHECKING COMPRESSOR EFFICIENCY	23
THERMOSTATIC EXPANSION VALVE	23
OVERFEEDING.....	23
UNDERFEEDING.....	23
SUPREHEAT	23
CECKING SUBCOOLING.....	24
CHECKING THERMOSTATIC EXPANSION VALVE OPERATION	25
NON-CONDENSABLES.....	25
COMPRESSOR BURNOUT	25
REFRIGERANT PIPING	26
DUCT STATIC PRESSURES AND/OR STATIC PRES- SURE DROP ACROSS COILS.....	30
AIR HANDLER EXTERNAL STATIC.....	30
COIL STATIC PRESSURE DROP.....	30
INDOOR UNIT TROUBLESHOOTING	32
HEAT PUMP ADVANCE FEATURE MENU	48
EMERGENCY MODE.....	51
SETTING THE MODE DISPLAY - OUTDOOR UNIT	56
CTK04 ADDENDUM	65
TROUBLESHOOTING	95
WIRING DIAGRAMS.....	110
ACCESSORIES.....	114

IMPORTANT NOTICES FOR CONSUMERS AND SERVICERS RECOGNIZE SAFETY SYMBOLS, WORDS AND LABELS

Pride and workmanship go into every product to provide our customers with quality products. It is possible, however, that during its lifetime a product may require service. Products should be serviced only by a qualified service technician who is familiar with the safety procedures required in the repair and who is equipped with the proper tools, parts, testing instruments and the appropriate service manual. **REVIEW ALL SERVICE INFORMATION IN THE APPROPRIATE SERVICE MANUAL BEFORE BEGINNING REPAIRS.**

WARNING

TO PREVENT THE RISK OF PROPERTY DAMAGE, PERSONAL INJURY, OR DEATH, DO NOT STORE COMBUSTIBLE MATERIALS OR USE GASOLINE OR OTHER FLAMMABLE LIQUIDS OR VAPORS IN THE VICINITY OF THIS APPLIANCE.

NOTICE

INVERTER H/P MODELS CAN ONLY BE MATCHED WITH AN AVPEC* AIR HANDLER OR TXV-V** EXPANSION VALVE KIT. DAMAGE RESULTING FROM OPERATION WITH ANY OTHER COMBINATION IS NOT COVERED BY OUR WARRANTIES.

SAFE REFRIGERANT HANDLING

While these items will not cover every conceivable situation, they should serve as a useful guide.

WARNING

REFRIGERANTS ARE HEAVIER THAN AIR. THEY CAN "PUSH OUT" THE OXYGEN IN YOUR LUNGS OR IN ANY ENCLOSED SPACE. TO AVOID POSSIBLE DIFFICULTY IN BREATHING OR DEATH:

- NEVER PURGE REFRIGERANT INTO AN ENCLOSED ROOM OR SPACE. BY LAW, ALL REFRIGERANTS MUST BE RECLAIMED.
- IF AN INDOOR LEAK IS SUSPECTED, THOROUGHLY VENTILATE THE AREA BEFORE BEGINNING WORK.
- LIQUID REFRIGERANT CAN BE VERY COLD. TO AVOID POSSIBLE FROST BITE OR BLINDNESS, AVOID CONTACT AND WEAR GLOVES AND GOGGLES. IF LIQUID REFRIGERANT DOES CONTACT YOUR SKIN OR EYES, SEEK MEDICAL HELP IMMEDIATELY.
- ALWAYS FOLLOW EPA REGULATIONS. NEVER BURN REFRIGERANT, AS POISONOUS GAS WILL BE PRODUCED.

WARNING

THE UNITED STATES ENVIRONMENTAL PROTECTION AGENCY ("EPA") HAS ISSUED VARIOUS REGULATIONS REGARDING THE INTRODUCTION AND DISPOSAL OF REFRIGERANTS INTRODUCED INTO THIS UNIT. FAILURE TO FOLLOW THESE REGULATIONS MAY HARM THE ENVIRONMENT AND CAN LEAD TO THE IMPOSITION OF SUBSTANTIAL FINES. THESE REGULATIONS MAY VARY BY JURISDICTION. SHOULD QUESTIONS ARISE, CONTACT YOUR LOCAL EPA OFFICE.

WARNING

HIGH VOLTAGE !

DISCONNECT ALL POWER BEFORE SERVICING.
MULTIPLE POWER SOURCES MAY BE PRESENT. FAILURE TO DO SO MAY CAUSE PROPERTY DAMAGE, PERSONAL INJURY OR DEATH.



WARNING

DO NOT CONNECT TO OR USE ANY DEVICE THAT IS NOT DESIGN CERTIFIED BY THE MANUFACTURER FOR USE WITH THIS UNIT. SERIOUS PROPERTY DAMAGE, PERSONAL INJURY, REDUCED UNIT PERFORMANCE AND/OR HAZARDOUS CONDITIONS MAY RESULT FROM THE USE OF SUCH NON-APPROVED DEVICES.

WARNING

TO AVOID POSSIBLE EXPLOSION:

- NEVER APPLY FLAME OR STEAM TO A REFRIGERANT CYLINDER. IF YOU MUST HEAT A CYLINDER FOR FASTER CHARGING, PARTIALLY IMMERSE IT IN WARM WATER.
- NEVER FILL A CYLINDER MORE THAN 80% FULL OF LIQUID REFRIGERANT.
- NEVER ADD ANYTHING OTHER THAN R-410A TO A RETURNABLE R-410A CYLINDER. THE SERVICE EQUIPMENT USED MUST BE LISTED OR CERTIFIED FOR THE TYPE OF REFRIGERANT USE.
- STORE CYLINDERS IN A COOL, DRY PLACE. NEVER USE A CYLINDER AS A PLATFORM OR A ROLLER.

OUTSIDE THE U.S., call 1-713-861-2500.

(Not a technical assistance line for dealers.) Your telephone company will bill you for the call.

IMPORTANT INFORMATION

WARNING

TO AVOID POSSIBLE EXPLOSION:

- USE ONLY RETURNABLE (NOT DISPOSABLE) SERVICE CYLINDERS WHEN REMOVING REFRIGERANT FROM A SYSTEM.
- ENSURE THE CYLINDER IS FREE OF DAMAGE WHICH COULD LEAD TO A LEAK OR EXPLOSION.
- ENSURE THE HYDROSTATIC TEST DATE DOES NOT EXCEED 5 YEARS.
- ENSURE THE PRESSURE RATING MEETS OR EXCEEDS 400 LBS.

WHEN IN DOUBT, DO NOT USE THE CYLINDER.

WARNING

TO AVOID POSSIBLE INJURY, EXPLOSION OR DEATH, PRACTICE SAFE HANDLING OF REFRIGERANTS.

CAUTION

THE COMPRESSOR PVE OIL FOR R-410A UNITS IS EXTREMELY SUSCEPTIBLE TO MOISTURE ABSORPTION AND COULD CAUSE COMPRESSOR FAILURE. DO NOT LEAVE SYSTEM OPEN TO ATMOSPHERE ANY LONGER THAN NECESSARY FOR INSTALLATION.

NOTICE

THE ENTIRE SYSTEM (COMBINATION OF INDOOR AND OUTDOOR SECTIONS) MUST BE MANUFACTURER APPROVED AND AIR-CONDITIONING, HEATING, AND REFRIGERATION INSTITUTE (AHRI) LISTED.

NOTE: INSTALLATION OF UNMATCHED SYSTEMS IS NOT PERMITTED. DAMAGE OR REPAIRS DUE TO INSTALLATION OF UNMATCHED SYSTEMS IS NOT COVERED UNDER THE WARRANTY.

NOTICE

APPROVED SYSTEMS ARE COMBINATION OF COMFORTBRIDGE COMPATIBLE INDOOR UNIT AND SINGLE-STAGE THERMOSTAT (WITH DEHUMIDIFICATION FUNCTION).
IF DO NOT USE COMFORTBRIDGE COMPATIBLE INDOOR UNIT, USE CTK04AE OR NEWER THERMOSTAT. (HEREINAFTER REFERRED TO AS "THERMOSTAT")

WARNING

SYSTEM CONTAMINANTS, IMPROPER SERVICE PROCEDURE AND/OR PHYSICAL ABUSE AFFECTING HERMETIC COMPRESSOR ELECTRICAL TERMINALS MAY CAUSE DANGEROUS SYSTEM VENTING.

Notice:

When the outdoor unit is connected to main power, the inverter board has a small current flowing into it to be prepared for operation when needed. Due to this, the Control Board components have to be cooled even when the unit is not running. For this cooling operation, the condenser fan may come on at any time, including in the winter months. Any obstruction to the outdoor fan should be avoided at all times when the unit is powered to prevent damage.

The successful development of hermetically sealed refrigeration compressors has completely sealed the compressor's moving parts and electric motor inside a common housing, minimizing refrigerant leaks and the hazards sometimes associated with moving belts, pulleys or couplings.

Fundamental to the design of hermetic compressors is a method whereby electrical current is transmitted to the compressor motor through terminal conductors which pass through the compressor housing wall. These terminals are sealed in a dielectric material which insulates them from the housing and maintains the pressure tight integrity of the hermetic compressor. The terminals and their dielectric embedment are strongly constructed, but are vulnerable to careless compressor installation or maintenance procedures and equally vulnerable to internal electrical short circuits caused by excessive system contaminants.

In either of these instances, an electrical short between the terminal and the compressor housing may result in the loss of integrity between the terminal and its dielectric embedment. This loss may cause the terminals to be expelled, thereby venting the vaporous and liquid contents of the compressor housing and system.

A venting compressor terminal normally presents no danger to anyone, providing the terminal protective cover is properly in place.

If, however, the terminal protective cover is not properly in place, a venting terminal may discharge a combination of
(a) hot lubricating oil and refrigerant
(b) flammable mixture (if system is contaminated with air)

in a stream of spray which may be dangerous to anyone in the vicinity. Death or serious bodily injury could occur.

Under no circumstances is a hermetic compressor to be electrically energized and/or operated without having the terminal protective cover properly in place. See Service Section for proper servicing.

PRODUCT IDENTIFICATION

NOMENCLATURES

	G	V	Z	C	20	036	1	AA		
	1	2	3	4	5,6	7,8,9	10	11,12		
Brand	G Goodman® Brand							Engineering *		
								Major/ Minor Revisions		
								* Not used for order or inventory control		
Product Category	S Split System									Electrical
	V Inverter Split System									1- 208/230 V, 1 Phase, 60 Hz
Unit Type	X Condenser R-410A									Capacity
	Z Heat Pump R-410A									024 2 Tons 048 4 Tons
								036 3 Tons		
Communication Feature	C Integrated communicating ComfortBridge™ Technology							Efficiency		
								16 16 SEER 18 18 SEER 20 20 SEER		

	A	V	Z	C	20	036	1	AA		
	1	2	3	4	5,6	7,8,9	10	11,12		
Brand	A Amana® Brand							Engineering *		
								Major/ Minor Revisions		
								* Not used for order or inventory control		
Product Category	S Split System									Electrical
	V Inverter Split System									1- 208/230 V, 1 Phase, 60 Hz
Unit Type	X Condenser R-410A									Capacity
	Z Heat Pump R-410A									024 2 Tons 048 4 Tons
								036 3 Tons 060 5 Tons		
Communication Feature	C Integrated communicating ComfortBridge™ Technology							Efficiency		
								16 16 SEER 18 18 SEER 20 20 SEER		

PRODUCT IDENTIFICATION

NOMENCLATURES

	A	V	P	E	C	25	B	1	4	AA	
	1	2	3	4	5	6,7	8	9	10	11,12	
Brand	A Single-Piece Air Handler										Engineering*
											Major/Minor Revisions
											*Not used for inventory management
Unit Application	R Multi Position PSC Motor S Multi Position EEM Motor V Multi Position Variable-Speed Motor - Communicating										Refrigerant Charge
											4 = R-410A
Cabinet Finish	U Unpainted P Painted										Electrical
											1 208/230V, 1 Phase, 60 Hz
Expansion Device	E Electronic Expansion Valve T Expansion Device V Inverter Tuned Expansion Valve										Cabinet Width
											B = 17½"
											C = 21"
											D = 24½"
											Nominal Capacity @ 13 SEER
											24 = 2 Tons 31 = 2½ Tons 48 = 4 Tons
											25 = 2 Tons 36 = 3 Tons 49 = 3-3½ Tons
											29 = 2 Tons 37 = 3½ Tons 59 = 4-5 Tons
											30 = 2½ Tons 42 = 3½ Tons 60 = 5 Tons
											61 = 4-5 Tons
											Communications
											C = ComfortNet™ Compatible

SYSTEM OPERATION

This section gives a basic description of heat pump condenser unit operation, its various components and their basic operation. Ensure your system is properly sized for heat gain and loss according to methods of the Air Conditioning Contractors Association (ACCA) or equivalent.

CONDENSING UNIT

The ambient air is pulled through the heat pump condenser coil by a direct drive propeller fan. This air is then discharged out of the top of the cabinet. These units are designed for free air discharge, so no additional resistance, like duct work, shall be attached.

The gas and liquid line connections on present models are of the sweat type for field piping with refrigerant type copper. Front seating valves are factory installed to accept the field run copper. The total refrigerant charge for a normal installation is factory installed in the heat pump condenser unit.

*VZC20 models are available in 2 through 5 ton sizes and use R-410A refrigerant. They are designed for 208/230 volt single phase applications.

*VZC20 R-410A model units use a Daikin rotary compressor. These models are ComfortBridge™ and ComfortNet™ ready.

There are a number of design characteristics which are different from the traditional compressors.

*VZC20 models use “FVC50K” which is NOT compatible with mineral oil based lubricants like 3GS. “FVC50K” oil (required by the manufacturer) must be used if additional oil is required.

NOTE: For models *VZC200601A* or earlier, use a Daikin Scroll compressor “FVC68D” oil”

COOLING

The refrigerant used in the system is R-410A. It is a clear, colorless, non-toxic and non-irritating liquid. R-410A is a 50:50 blend of R-32 and R-125. The boiling point at atmospheric pressure is -62.9°F.

A few of the important principles that make the refrigeration cycle possible are: heat always flows from a warmer to a cooler body. Under lower pressure, a refrigerant will absorb heat and vaporize at a low temperature. The vapors may be drawn off and condensed at a higher pressure and temperature to be used again.

The indoor evaporator coil functions to cool and dehumidify the air conditioned spaces through the evaporative process taking place within the coil tubes.

NOTE: The pressures and temperatures shown in the refrigerant cycle illustrations on the following pages are for demonstration purposes only. Actual temperatures and pressures are to be obtained from the “Expanded Performance Chart”.

Liquid refrigerant at condensing pressure and temperatures leaves the outdoor condensing coil through the drier and is metered into the indoor coil through the metering device. As the cool, low pressure, saturated refrigerant enters the tubes of the indoor coil, a portion of the liquid immediately vaporizes. It continues to soak up heat and vaporizes as it proceeds through the coil, cooling the indoor coil down to about 48°F.

Heat is continually being transferred to the cool fins and tubes of the indoor evaporator coil by the warm system air. This warming process causes the refrigerant to boil. The heat removed from the air is carried off by the vapor.

As the vapor passes through the last tubes of the coil, it becomes superheated. That is, it absorbs more heat than is necessary to vaporize it. This is assurance that only dry gas will reach the compressor. Liquid reaching the compressor can weaken or break compressor valves.

The compressor increases the pressure of the gas, thus adding more heat, and discharges hot, high pressure superheated gas into the outdoor condenser coil.

In the condenser coil, the hot refrigerant gas, being warmer than the outdoor air, first loses its superheat by heat transferred from the gas through the tubes and fins of the coil. The refrigerant now becomes saturated, part liquid, part vapor and then continues to give up heat until it condenses to a liquid alone. Once the vapor is fully liquefied, it continues to give up heat which subcools the liquid, and it is ready to repeat the cycle.

The inverter system can stop the compressor or outdoor fan to protect the unit. The inverter system can run higher compressor speed than required from thermostat to recover compressor oil that flows.

HEATING

The heating portion of the refrigeration cycle is similar to the cooling cycle. By de-energizing the reversing valve solenoid coil, the flow of the refrigerant is reversed. The indoor coil now becomes the heat pump condenser coil, and the outdoor coil becomes the evaporator coil. The check valve at the outdoor coil will be forced closed by the refrigerant flow, thereby utilizing the outdoor expansion device. An electronic expansion valve meters the condensed refrigerant to the outdoor coil.

SYSTEM OPERATION

DEFROST CYCLE

The defrosting of the outdoor coil is controlled by the Control Board and the outdoor coil temperature thermistor and defrost sensor. The outdoor coil temperature thermistor (Tm) sensor is clamped to a return bend entering the outdoor coil and the defrost sensor at bottom flowrator leg at outdoor coil outlet. Defrost timing periods of 30, 60, 90 or 120 minutes may be selected via the thermostat setting. Control Board will initiate time defrost at the interval selected from the thermostat. During operation, the microprocessor on the Control Board checks the two coil and defrost temperature (Tm and Tb) via sensors every 5 seconds in heating mode. When the Control Board detects the coil temperature to be high enough (approximately 54 °F) and defrost sensor more than 43 °F for 30 seconds, the defrost cycle is terminated and the timing period is reset. The field service personnel can also advance a heat pump to the defrost cycle by selecting “force defrost” option from thermostat.

SYSTEM STARTUP TEST

NOTICE

ON INITIAL POWER START-UP, THE OUTDOOR UNIT WILL DISPLAY CODE E11, SIGNALING THAT INITIAL SYSTEM TEST MUST BE RUN. FOLLOW THE INSTRUCTIONS BELOW TO INITIATE AND COMPLETE THE TESTING.

A system verification test is now required to check the equipment settings and functionality.

Inverter units are tested by any of the following methods:

- setting the “SUT” menu (System verification test) to ON through the indoor unit control board push buttons.
- setting the System verification test menu of mode display screen-4 to ON through the outdoor unit control board push buttons.
- Through the CoolCloud HVAC phone application.

Once selected, it checks the equipment for approximately 5 - 15 minutes. System test may exceed 15 minutes if there is an error. Refer to the Troubleshooting section, if error code appears.

Before starting the SYSTEM TEST, turn off the electric heater and gas furnace.

NOTE: If the unit is attempting to run SYSTEM TEST in under 20°F ambient temperature, the unit may not be able to complete the test due to low suction pressure. In such a case, re-run the SYSTEM TEST when the ambient temperature exceeds 20° F.

COOLCLOUD™ HVAC PHONE APPLICATION

The CoolCloud HVAC phone application designed to improve the contractor’s setup /diagnostic experience. This application can only use with the ComfortBridge compatible indoor unit and can download through CoolCloud website at <https://www.coolcloudhvac.com>, Google Play or the Apple App Store.

Users can see specific model information, review active diagnostic error codes, observe system status during operation, make system menu adjustments, add site visit notes and run system testing of all operational modes (heat / cool / fan) directly from the phone.

The phone application is also capable of directly updating the ComfortBridge compatible indoor unit software anytime updates are available.

The application will automatically notify the user if updates are available.

NOTE: The software update may take up to 20 minutes to complete.

If Installing with a CTK04 thermostat, please see the addendum for further instructions.

CHARGE MODE

CHARGE mode allows for charging of the system. System operates for a duration of approximately one hour while the equipment runs at full capacity. After one hour, the CHARGE MODE ends and the system resumes normal operation. Before starting the CHARGE MODE, turn off the Cool or Heat mode and electric heater or gas furnace.

- a. Inverter units are charged by any of the following methods:
 - setting the “CR9” menu (Charge Mode) to ON through the indoor unit control board push buttons.
 - setting the Charge mode menu of mode display screen-4 to ON through the outdoor unit control board push buttons.
 - Through the CoolCloud HVAC phone application.
- b. The System will remain in charge mode (high speed) for 60 minutes before timing out.
- c. When charge mode once complete, the installer must manually shut off.

If Installing with a CTK04 thermostat, please see the addendum for further instructions.

SYSTEM OPERATION

BOOST MODE

BOOST MODE can be enabled or disabled through the control board push buttons or through the CoolCloud app.

BOOST MODE allows the system to operate at increased compressor speed to satisfy unusual high loads. BOOST MODE is initiated by an outdoor temperature sensor located in the outdoor unit.

Please note that outdoor equipment operational sound levels may increase while the equipment is running in BOOST MODE. Disabling BOOST MODE will provide the quietest and most efficient operation.

NOTE: BOOST MODE is applicable only for *VZC200**1AB or later revision.

BOOST MODE is ON by default and is activated when the outdoor temperature reaches 105°F. BOOST MODE can be disabled and enabled and the activation temperature adjusted in the Settings menu of the CoolCloud app or through the indoor / outdoor push button menus. If Installing with a CTK04 thermostat, please see the addendum for further instructions.

DEHUMIDIFICATION

The thermostat reads the indoor humidity level and allows the user to set a dehumidification target based on these settings. The thermostat controls the humidity level of the conditioned space using the cooling system. Dehumidification is engaged whenever a cooling demand is present and structural humidity levels are above the target level. When this condition exists, the circulating fan output is reduced, increasing system run time, over cooling the evaporator coil and ultimately removing more humidity from the structure than if only in cooling mode. The thermostat also allows for an additional overcooling limit setting from 0°F to 3°F setup. This allows the cooling system to further reduce humidity by lowering the temperature up to 3°F below the cooling setpoint in an attempt to better achieve desired humidity levels.

DEHUMIDIFICATION TIPS*

For effective dehumidification operation:

- Ensure “Dehumidification” is not set to “OFF”
- Verify the cooling airflow profile (cool profiles) is set to “Profile D”.
 - See the Cool Set-up section of the Installation Manual for complete airflow profile details.
 - By default, “dehumidification selection” is standard and the cooling airflow profile is set to “ProfileD”
- For additional dehumidification control, airflow settings are field adjustable and can be fine-tuned to a value that is comfortable for the application from a range of Cool Airflow Trim.

- In addition, the system can have Enhanced Dehumidification operation in setting “A”, “B”, or “C” of dehumidification based on dehumidification demand.
 - See the Dehumidification Select section for more detail.
- *The specification of *VZC200241AF, 0361AE, 0481AE, and 0601AE or earlier models are different from this specification. For details, see the Installation Manual or Service Manual that matches the Major and Minor revision of the model name.

COMFORTBRIDGE™ SYSTEM OVERVIEW

The ComfortBridge based inverter heating and air conditioning system uses an indoor unit and outdoor unit digitally communicating with one another via a two-way communications path.

The 24 VAC single-stage thermostat sends commands to the indoor and outdoor units.

The indoor and outdoor units interacting with one another directly while taking simple analog commands from the thermostat are the core of unlocking the benefits and features of the ComfortBridge control system.

NOTE: It is strongly recommend the use of thermostat with humidity sensor and dehumidification terminal. Without these functions, Dehumidification operation does not work.

COMFORTBRIDGE SYSTEM ADVANCED FEATURES

The ComfortBridge system permits access to additional system information, advanced set-up features, and advanced diagnostic/troubleshooting features via the control board push buttons or the CoolCloud mobile app. (If using a CTK04 thermostat, please see the addendum for further instructions.)

FAULT CODE HISTORY

The heat pump’s diagnostics menu provides access to the most recent faults. The six most recent faults can be accessed through the control board seven segment displays or the CoolCloud mobile app. Any consecutively repeated fault is stored a maximum of three times.

Example: A leak in the system, low refrigerant charge or an incompletely open stop valve can cause the unit to flash error code E15. This error code suggests that the unit is experiencing operation at low pressure. The control will only store this fault the first three consecutive times the fault occurs.

NOTE: The fault list can be cleared after performing maintenance or servicing the system to assist in the troubleshooting process.

SYSTEM OPERATION

DEVICE STATUS

This menu displays information about the systems current status. This menu can be utilized to confirm correct functionality of the equipment and for troubleshooting purposes.

The following items will be displayed:

- Heat Capacity Request Percentage
- Cool Capacity Request Percentage
- Heat Capacity Request During Defrost Percentage
- Dehumidification Request Percentage
- Reversing Valve Status
- Reported Airflow by Indoor Unit
- Boost Mode
- Previous Defrost Run Time

SENSOR DATA

The following sensor items will be displayed:

- Outdoor Temperature
- Coil Temperature
- Liquid Line Temperature
- Discharge Temperature
- Defrost Sensor
- Suction Pressure

PUMP DOWN / CHARGE MODE

This function can be enabled this menu.

SET 7-SEGMENT MODE DISPLAY TO PUMP DOWN

Please follow the following sequence to enter PUMP DOWN to accumulate the refrigerant to outdoor unit by 7 Segment Mode. Do not operate COOL ON or HEAT ON mode to enter PUMP DOWN.

Before starting the PUMP DOWN operation, change indoor fan trim, delay and profile back to default and stop electric heater and gas furnace. Remove if no trim feature. In this operation, the gas and liquid service valve should be opened.

1. Set 7-segment display to SCREEN 4 (SETTING MODE 2) Setting No. 8 and change the display from “-01” to “-00” System will then automatically start PUMP DOWN operation. For information on how to set 7-segment display, see the section SETTING THE MODE DISPLAY in this manual.
2. Approximately one minute later, the compressor should start operating. Check the amperage at the compressor wiring to see the compressor operation status. Unit display error code E11 (System verification Test) once the PUMP DOWN operations starts.
3. Close liquid service valve approximately two minutes after compressor has come on.
4. Compressor will come to a stop automatically. Close the suction service valve immediately after the compressor

stops. After completion of PUMP DOWN, unit shows error code “E11”.

NOTE: Refrigerant cannot be collected to the outdoor unit completely if the system is overcharged or if there is a delay in closing the liquid service valve and suction service valve. Evacuate the left over refrigerant from the system using a recovery machine.

SYSTEM VERIFICATION TEST

The mandatory system verification test is enabled from this menu, which enables a functional check of the equipment, in addition to ensuring proper stop valve position.

COOL SET-UP

The system allows for the adjustment of several cooling performance variables. Cool Airflow Trim (*1), Cool Airflow Profiles, Cool Fan ON Delay, Cool Fan OFF Delay and Dehumidification Select (some enable option or off) can be adjusted in this menu. You can also reset this entire menu to factory default settings.

See the following images showing the four cooling airflow profiles.

COOLING AIRFLOW PROFILE

- Profile A provides only an OFF delay of one (1) minute at 100% of the cooling demand airflow.

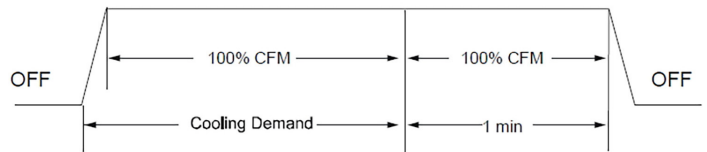

- Profile B ramps up to full cooling demand airflow by first stepping up to 50% of the full demand for 30 seconds. The motor then ramps to 100% of the required airflow. A one (1) minute OFF delay at 100% of the cooling airflow.

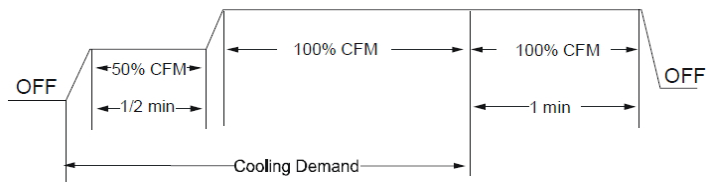

- Profile C ramps up to 82% of the full cooling demand airflow and operates there for approximately 7 1/2 minutes. The motor then steps up to the full demand airflow. Profile C also has a one (1) minute 100% OFF delay.

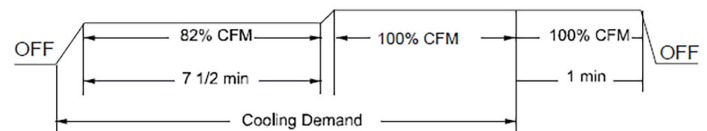

SYSTEM OPERATION

- Profile D (default) ramps up to 50% of the demand for 1/2 minute, then ramps to 82% of the full cooling demand airflow and operates there for approximately 7 1/2 minutes. The motor then steps up to the full demand airflow. Profile D has a 1/2 minute at 50% airflow OFF delay.

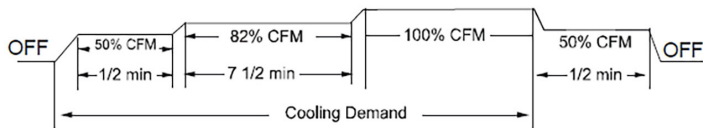

HEAT SET-UP

This menu allows for the adjustment of several heating performance variables. Heat Airflow trim (*1), Heat Fan ON Delay, Heat Fan OFF Delay and timed Defrost interval can be adjusted in this menu. Time interval of 30, 60, 90 and 120 minutes between two defrost cycles can be set to suit the weather conditions and performance of the unit.

SET THERMOSTAT TO ADJUST INDOOR AIR CFM TRIM*1

User can change the airflow trim at high, intermediate and low for cooling and heat pump heating mode.

Select:

Cool/Heat Airflow Trim (High): high speed cooling/heating

Cool/Heat Airflow Trim (Int): intermediate speed cooling/heating

Cool/Heat Airflow Trim (Low): low speed cooling/heating Under each trim setting, the airflow can be increased or decreased by a certain percentage.

*1

- At Cool and Heat Hi speed trim, *VZC200601* with **VC960804C, **VM970804C and *MVC800804C combination trim more than 5% settings are invalid. Trimmed up CFM makes miss matching error.
- At Cool Hi speed trim, Other than the above, depending on the connected indoor unit, there are restrictions on the positive side Trim setting.
If you want to change the Cool Airflow Trim to positive side, be sure to confirm the Airflow Trim restrictions in the latest indoor unit installation manual. The latest manual can be obtained from the website "PartnerLink(InfoFinderPlus/ Literature)".
[PartnerLink URL]
<https://partnerlinkmarketing.goodmanmfg.com/goodman/info-finder-plus>
- At Cool Intermediate and Low speed trim, The Inverter system uses lower compressor speed and lower indoor unit CFM to optimize system performance. To obtain 100% CFM for home circulation, use full Trim setting instead of Int/Low speed. This is recommended for applications with unusually cold return temperatures such as basements.

DEHUMIDIFICATION SELECT*

When Dehumidification mode exists, the circulating fan output is reduced, increasing system run time, over cooling the evaporator coil and ultimately removing more humidity from the structure than if only in cooling mode.

The system can have Dehumidification operation in setting "Standard", "A", "B" or "C" of "dehumidify with cooling" menu based on dehumidification demand.

Setting "Standard" allows for the widest compressor operation range with lower CFM than Cooling mode.

In the Enhanced Dehumidification (setting A, B and C) the indoor airflow is lower than Standard Dehumidification (Standard).

Setting "A" allows for the same compressor operation range in Dehumidification operation with lower CFM than standard dehumidification (Standard).

Setting "B" limits compressor operation range and keeps high dehumidification capacity.

In setting "C" the system runs fixed at 100% compressor and airflow. See Figure 1.

NOTE: In high humidity environments, sweating on supply ducts, cased coils or air handler cabinets can become an issue in Enhanced Dehumidification operation. It is strongly recommended covering then with 2" fiberglass insulation for these installations.

* The specification of *VZC200241AF, 0361AE, 0481AE and 0601AE or earlier models are different from this specification.

For details, see the Installation Manual or Service Manual that matches the Major and Minor revision of model name.

SYSTEM OPERATION

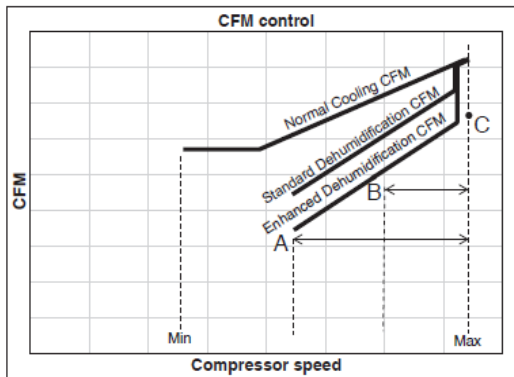

Figure 1

MAX COMPRESSOR RPS FOR COOLING/HEATING (SELECTED RPS/ RPS range)

Max compressor speed at which the outdoor unit will operate can be changed through the control board seven segment displays or the CoolCloud mobile app.

Max compressor speed can be changed to get the required capacity or efficiency.

Once the maximum speed is set, the system operates between the set maximum speed and default low speed.

When determining the appropriate compressor speed for cooling and heating, in the "RPS Range For Cooling/ Heating" menu select the range that contains the desired value. (Then, after pressing the Apply Changes button, leave the Device setting menu and enter this menu again.

Otherwise, the changed settings will not be reflected.) Next, in the "Selected RPS for Cooling/Heating" menu, select the desired RPS within the displayed range.

SYSTEM OPERATION

COOLING CYCLE

NOTICE

THE SPECIFICATION OF *VXC200601A OR EARLIER MODELS ARE DIFFERENT FROM THIS SPECIFICATION. FOR DETAILS, SEE THE SERVICE MANUAL THAT MATCHES THE MAJOR REVISION OF MODEL NAME.

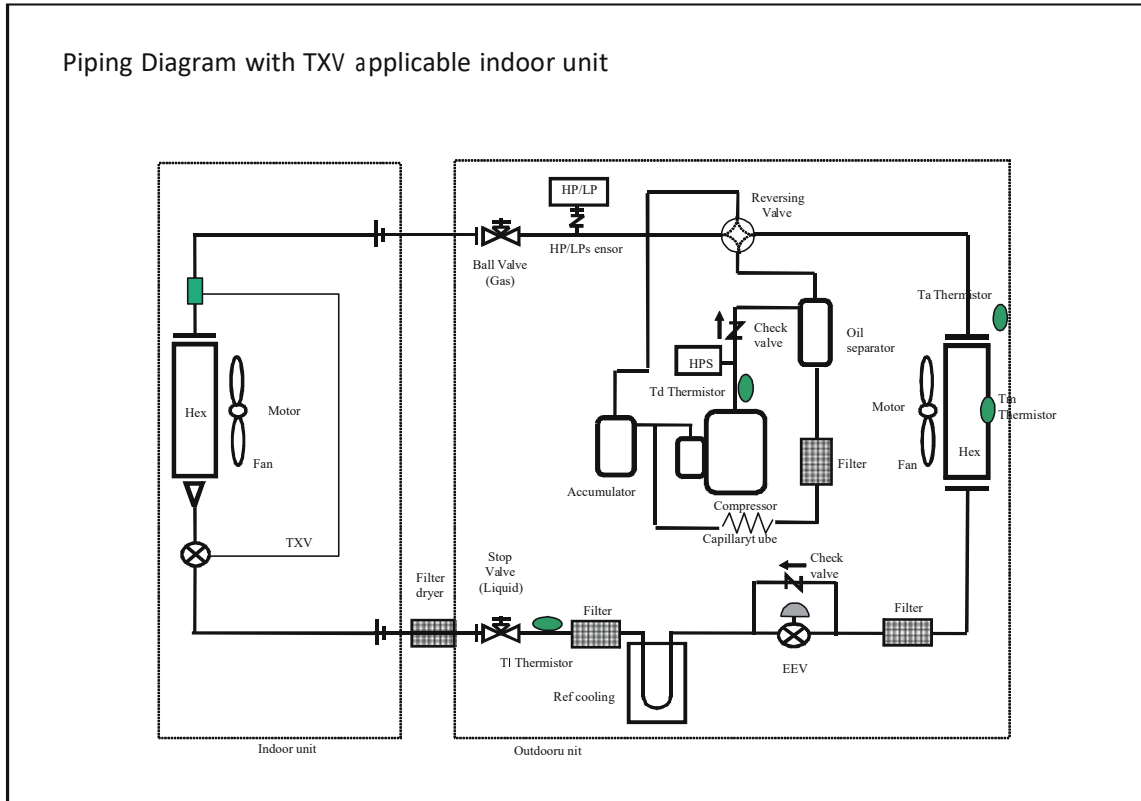

LEGEND:

TL =Thermistor(Outdoor Liquid Temperature)
 Td =Thermistor(Discharge Temperature)
 Ta =Thermistor(Outdoor Air Temperature)

HP/LP sensor= High/Low Pressure Sensor
 HPS= High Pressure Switch
 Tm =Thermistor(Outdoor Coil Temperature)

SYSTEM OPERATION

COOLING CYCLE

NOTICE

THE SPECIFICATION OF *VXC200601A OR EARLIER MODELS ARE DIFFERENT FROM THIS SPECIFICATION. FOR DETAILS, SEE THE SERVICE MANUAL THAT MATCHES THE MAJOR REVISION OF MODEL NAME.

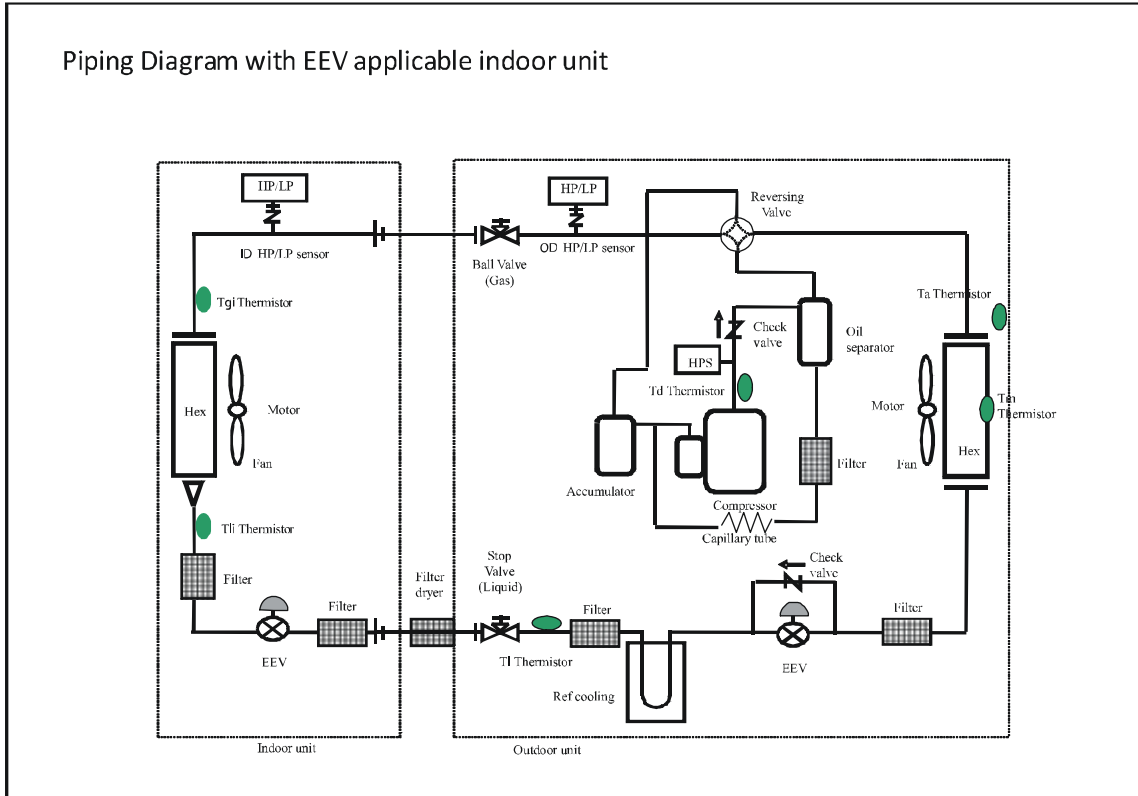

LEGEND:

Tl = Thermistor (Outdoor Liquid Temperature)
 Td = Thermistor (Discharge Temperature)
 Ta = Thermistor (Outdoor Air Temperature)
 Tm = Thermistor (Outdoor Coil Temperature)

Tli = Thermistor (Indoor Liquid Temperature)
 Tgi = Thermistor (Indoor Gas Temperature)
 ID HP/LP sensor = Indoor High/Low Pressure Sensor
 OD HP/LP sensor = Outdoor High/Low Pressure Sensor
 HPS = High Pressure Switch

SERVICING

CHECKING VOLTAGE

1. Remove outer case, control panel cover, etc., from unit being tested.
With power ON:

 **WARNING**

LINE VOLTAGE NOW PRESENT.

2. Using a voltmeter, measure the voltage across terminals L1 and L2 of the contactor for the heat pump condenser unit or at the field connections for the air handler or heaters.
ComfortNet™ Ready Heat Pump Condenser Units: Measure the voltage across the L1 and L2 lugs on the unitary (UC) control.
3. No reading - indicates open wiring, open fuse(s) no power or etc., from unit to fused disconnect service. Repair as needed.
4. With ample voltage at line voltage connectors, energize the unit.

Unit Type	Unit Supply Voltage (VAC)		
	voltage	min.	max.
Outdoor Unit, Air Handler, Modular Blower, Heater Kit	208/230	197	253
Gas Furnaces	115	103	126

NOTE: When operating electric heaters on voltages other than 240 volt, refer to the System Operation section on electric heaters to calculate temperature rise and air flow. Low voltage may cause insufficient heating.

CHECKING WIRING

 **WARNING**

HIGH VOLTAGE !

DISCONNECT ALL POWER BEFORE SERVICING OR INSTALLING. MULTIPLE POWER SOURCES MAY BE PRESENT. FAILURE TO DO SO MAY CAUSE PROPERTY DAMAGE, PERSONAL INJURY OR DEATH.



1. Check wiring visually for signs of overheating, damaged insulation and loose connections.
2. Use an ohmmeter to check continuity of any suspected open wires.
3. If any wires must be replaced, replace with comparable gauge and insulation thickness.

CHECKING THERMOSTAT AND WIRING

Communicating Thermostat Wiring: The maximum wire length for 18 AWG thermostat wire is 250 feet.

THERMOSTAT AND WIRING

 **WARNING**

LINE VOLTAGE NOW PRESENT.

With power ON, thermostat calling for cooling/heating.

1. Use a voltmeter to check for 24 volt at thermostat wires C and R in the indoor unit control panel.
2. No voltage indicates trouble in the thermostat, wiring or transformer source.
3. Check the continuity of the thermostat and wiring. Repair or replace as necessary.

 **WARNING**

LINE VOLTAGE NOW PRESENT.

Resistance Heaters

With power ON:

1. Set room thermostat to a higher setting than room temperature so both stages call for heat.
2. With voltmeter, check for 24 volt at each heater relay.
3. No voltage indicates the trouble is in the thermostat or wiring.
4. Check the continuity of the thermostat and wiring. Repair or replace as necessary.

NOTE: Consideration must be given to how the heaters are wired (O.D.T. and etc.). Also safety devices must be checked for continuity.

THERMOSTAT COMFORTBRIDGE™ SYSTEM OVERVIEW

The ComfortBridge based inverter heating and air conditioning system uses an indoor unit and outdoor unit digitally communicating with one another via a two-way communications path.

The 24 VAC single-stage thermostat sends commands to the indoor and outdoor units.

The indoor and outdoor units interacting with one another directly while taking simple analog commands from the thermostat are the core of unlocking the benefits and features of the ComfortBridge control system.

NOTE:

It is **strongly** recommend the use of thermostat with humidity sensor and dehumidification terminal. Without these functions, Dehumidification operation does not work.

COMFORTBRIDGE™ SYSTEM WIRING

ComfortBridge™ control system is low voltage wiring consists of two wires between the indoor unit and outdoor unit.

SERVICING

The required wires are data lines 1 and 2.

The thermostat needs 4 wires between the indoor unit and thermostat or 5 wires if the thermostat requires a Common wire.

NOTE:

Regarding the wiring of the indoor unit to the thermostat, also refer to ComfortBridge compatible indoor unit's Install manual (in case of communicating inverter system.).

If Installing with a CTK04 thermostat, please see the addendum for further instructions.”

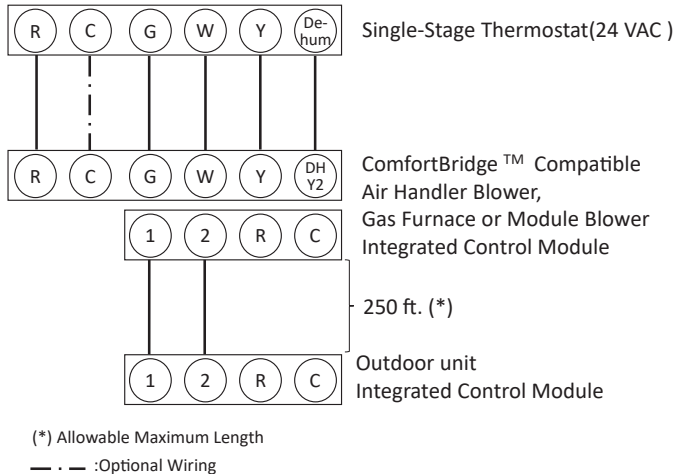

SYSTEM WIRING

CHECKING TRANSFORMER AND CONTROL CIRCUIT

WARNING

HIGH VOLTAGE !

DISCONNECT ALL POWER BEFORE SERVICING OR INSTALLING. MULTIPLE POWER SOURCES MAY BE PRESENT. FAILURE TO DO SO MAY CAUSE PROPERTY DAMAGE, PERSONAL INJURY OR DEATH.

A step-down transformer (208/230 volt primary to 24 volt secondary) is provided with each indoor unit. This allows ample capacity for use with resistance heaters. The outdoor sections do not contain a transformer (see note below). (see indoor unit WIRING DIAGRAM)

WARNING

DISCONNECT ALL POWER BEFORE SERVICING.

1. Remove control panel cover, or etc., to gain access to transformer.
- With power ON:

WARNING

LINE VOLTAGE NOW PRESENT.

2. Using a voltmeter, check voltage across secondary voltage side of transformer (R to C).

3. No voltage indicates faulty transformer, bad wiring, or bad splices.
4. Check transformer primary voltage at incoming line voltage connections and/or splices.
5. If line voltage available at primary voltage side of transformer and wiring and splices good, transformer is inoperative. Replace.

CHECKING HIGH PRESSURE SWITCH

WARNING

HIGH VOLTAGE !

DISCONNECT ALL POWER BEFORE SERVICING OR INSTALLING. MULTIPLE POWER SOURCES MAY BE PRESENT. FAILURE TO DO SO MAY CAUSE PROPERTY DAMAGE, PERSONAL INJURY OR DEATH.

The high pressure switch senses the pressure in the compressor discharge line. If abnormally high condensing pressures develop, the contacts of the control open, breaking the control circuit before the compressor motor overloads. This control is automatically reset.

1. Using an ohmmeter, check across the X32A connection on outdoor unit PCB high pressure control, with wire removed. If not continuous, the contacts are open.
2. Attach a gauge to the dill valve port on the base valve. With power ON:

WARNING

LINE VOLTAGE NOW PRESENT.

3. Start the system in charge mode and place a piece of cardboard in front of the outdoor coil, raising the condensing pressure.
4. Check pressure at which the high pressure control cuts-out. If it cuts-out at 605 PSIG to -17 PSIG, it is operating normally (See causes for high head pressure in Service Problem Analysis Guide). If it cuts out below this pressure range, replace the control.

CHECKING OUTDOOR HI/LOW PRESSURE SENSOR

The HI/LOW pressure sensor senses the suction pressure in cooling mode, and the discharge pressure in heating mode. Follow the following sequence to check the pressure sensor.

1. Connect manifold gauge to the air conditioner unit
2. Connect a pair of extended Molex probe tips to your voltmeter test leads.
3. Find the suction pressure in the cool mode, or discharge pressure in the heat mode (terminals) Locate (X17A) connection and connect a DC voltmeter across sensor terminals 1 and 3, (black and white wires) and record the DC voltage.

SERVICING

- Compare your readings to the detected pressure vs output voltage in the following table. Replace the sensor if the sensor is open, shorted, or outside of the voltage range.

⚠ WARNING

LINE VOLTAGE NOW PRESENT.

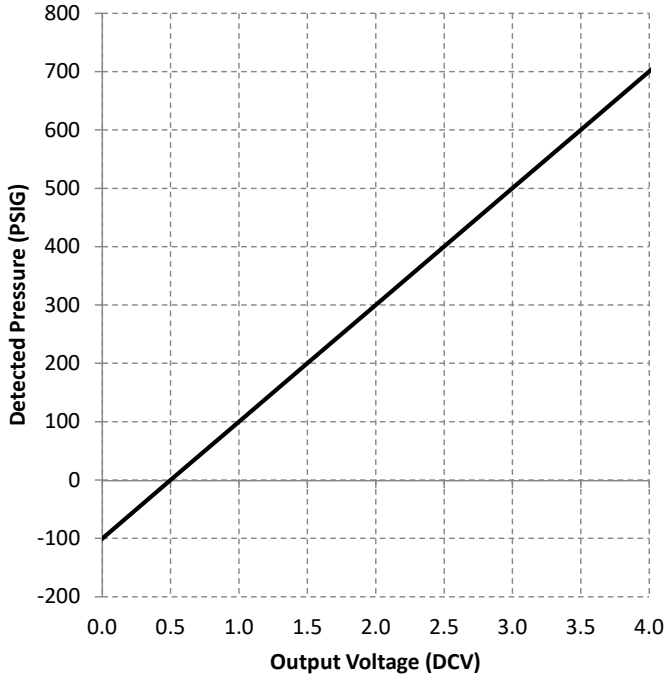

VOLTAGE AND PRESSURE CHARACTERISTICS

CHECKING COMPRESSOR

⚠ WARNING

Hermetic compressor electrical terminal venting can be dangerous. When insulating material which supports a hermetic compressor or electrical terminal suddenly disintegrates due to physical abuse or as a result of an electrical short between the terminal and the compressor housing, the terminal may be expelled, venting the vapor and liquid contents of the compressor housing and system.

If the compressor terminal PROTECTIVE COVER and gasket (if required) are not properly in place and secured, there is a remote possibility if a terminal vents, that the vaporous and liquid discharge can be ignited, spouting flames several feet, causing potentially severe or fatal injury to anyone in its path.

This discharge can be ignited external to the compressor if the terminal cover is not properly in place and if the discharge impinges on a sufficient heat source.

Ignition of the discharge can also occur at the venting terminal or inside the compressor, if there is sufficient contaminant air present in the system and an electrical arc

occurs as the terminal vents.

Ignition cannot occur at the venting terminal without the presence of contaminant air, and cannot occur externally from the venting terminal without the presence of an external ignition source.

Therefore, proper evacuation of a hermetic system is essential at the time of manufacture and during servicing. To reduce the possibility of external ignition, all open flame, electrical power, and other heat sources should be extinguished or turned off prior to servicing a system.

COMPRESSOR WINDING INSULATION TEST

The Inverter on the outdoor control board takes the position signal from the UVW line, connected with the compressor. If the system detects a malfunction on the compressor, check the insulation resistance in accordance with the following procedure.

⚠ WARNING

HIGH VOLTAGE!
Disconnect ALL power before servicing or installing. Multiple power sources may be present. Failure to do so may cause property damage, personal injury or death.



- Remove the leads from the compressor terminals.
- Using a Megometer, attach one lead to ground.
- Using the other lead of the Megometer, check the insulation between U to ground, V to ground, W to ground.

⚠ WARNING

See warnings S-17 before removing compressor terminal cover.

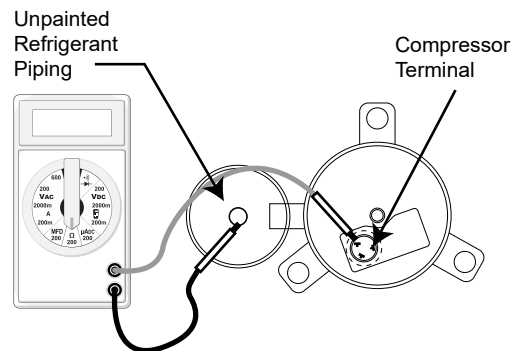

TESTING COMPRESSOR WINDINGS INSULATION

NOTE: The 2, 3, and 4 ton compressor has a terminal on the top. The 5 ton compressor has the terminals on the side. If the insulation resistance of the compressor is less than 100k Ohms between U to ground, V to ground, W to ground, replace the compressor.

SERVICING

NOTE: If an open compressor is indicated, allow ample time for the internal overload to reset before replacing compressor.

GROUND TEST

If fuse, circuit breaker, ground fault protective device, etc., has tripped, this is a strong indication that an electrical problem exists and must be found and corrected. The circuit protective device rating must be checked, and its maximum rating should coincide with that marked on the equipment nameplate.

With the terminal protective cover in place, it is acceptable to replace the fuse or reset the circuit breaker ONE TIME ONLY to see if it was just a nuisance opening. If it opens again, DO NOT continue to reset.

Disconnect all power to unit, making sure that all power legs are open.

1. DO NOT remove protective terminal cover. Disconnect the three leads going to the compressor terminals at the nearest point to the compressor.
2. Identify the leads and using an ohmmeter on the R x 10,000 scale or the highest resistance scale on your ohmmeter check the resistance between each of the three leads separately to ground (such as an unpainted tube on the compressor).
3. If a ground is indicated, then carefully remove the compressor terminal protective cover and inspect for loose leads or insulation breaks in the lead wires.
4. If no visual problems indicated, carefully remove the leads at the compressor terminals.
5. Carefully retest for ground, directly between compressor terminals and ground.
6. If ground is indicated, replace the compressor. The resistance reading should be infinity. If there is any reading on meter, there is some continuity to ground and compressor should be considered defective.

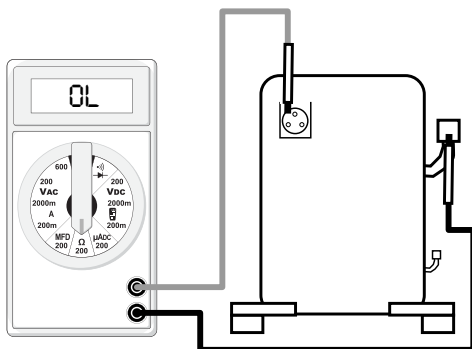

WARNING
Damage can occur to the glass embedded terminals if the leads are not properly removed. This can result in terminal and hot oil discharging.

TESTING CRANKCASE HEATER (OPTIONAL)

The crankcase heater must be energized a minimum of 2 hours before the unit is operated. Crankcase heaters are used to prevent migration or accumulation of refrigerant in the compressor crankcase during the off cycles and prevents liquid slugging or oil pumping on start up. A crankcase heater will not prevent compressor damage due to a flood-back or over charge condition.

WARNING
Disconnect ALL power before servicing.

1. Disconnect the heater lead in wires.
2. Using an ohmmeter, check heater continuity - should test continuous. If not, replace.

NOTE: The positive temperature coefficient crankcase heater is a 33 watt 240 voltage heater. The cool resistance of the heater will be approximately 1745 ohms. The resistance will become greater as the temperature of the compressor shell increases.

TESTING TEMPERATURE SENSORS RESISTANCE

The *VZC20 outdoor units and AVPEC* indoor units are factory equipped with:

- (Ta) an outdoor air temperature sensor
- (Tm) an outdoor coil temperature sensor
- (TI) an outdoor liquid temperature sensor
- (Td) a discharge temperature sensor
- (Tb) a defrost temperature sensor
- (Tgi) an indoor gas temperature sensor
- (Tli) an indoor liquid temperature sensor

To check above sensors:

WARNING
HIGH VOLTAGE!
Disconnect ALL power before servicing or installing. Multiple power sources may be present. Failure to do so may cause property damage, personal injury or death.

1. Disconnect power to the heat pump condenser.
2. Disconnect the sensor from the electric board.
3. Connect an ohmmeter across the sensor terminals. The ohmmeter should read be the resistance shown in the table THERMISTOR RESISTANCE AND TEMPERATURE CHARACTERISTICS. Replace the sensor if the sensor is open, shorted, or outside the valid resistance range.

SERVICING

TESTING EEV COIL RESISTANCE

To check the resistance of the EEV coil, first disconnect EEV cable from the Control board. Make measurements of resistance between the connector pins, and then make sure the resistance falls in the range of 40 to 50Ω.

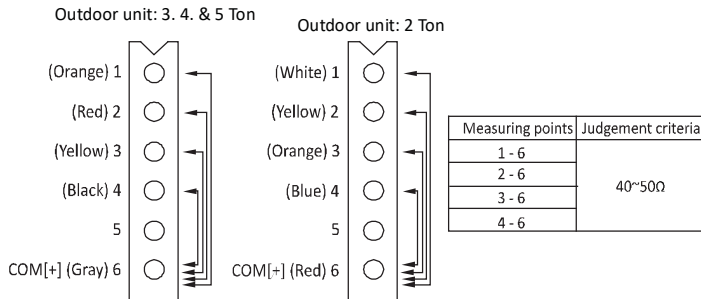

TESTING REVERSING VALVE

CHECKING REVERSING VALVE AND SOLENOID

Reversing valve used in heat pumps could potentially leak internally. Discharge gases can leak into the suction inside the valve. Compound gages will give the same symptoms as bad compressor valves or broken scroll flanks. The temperature between true suction and the suction line after the valve should not be greater than 4 degrees. Note: The center tube is always the suction line and should be cold.

TROUBLESHOOTING THE REVERSING VALVE FOR ELECTRICAL FAILURE

Place unit into the cooling mode. Test for 24 volts at the solenoid. If there is no voltage present at coil, check the control voltage. If voltage is present, loosen the nut on the top of the coil. Remove the coil, there should be slight resistance. If the slight resistance is felt, remove the coil. As you remove the coil listen carefully, an audible click should be detected. The clicking is due to the movement of the pilot valve plunger. The absence of a clicking sound indicates the plunger is stuck.

TROUBLESHOOTING MECHANICAL FAILURES ON A REVERSING VALVE BY PRESSURE

Troubleshooting the reversing valve can be done by pressure and touch. Raise the head pressure. In the cooling mode block the fan exhaust. Once head pressure has been raised, cycle between cooling and heating and see if the piston can be freed.

TROUBLESHOOTING MECHANICAL FAILURES ON A REVERSING VALVE BY TEMPERATURE

When operating properly the valve contains refrigerant gases at certain temperatures. The discharge line should be the same temperature after the valves discharge line. The true suction should be the same as the suction line after the valve. If there is a 4-degree difference, valve is

leaking. When stuck in the mid-position, part of the discharge gas from the compressor is directed back to the suction side, resulting in excessively high suction pressure. An increase in the suction line temperature through the reversing valve can also be measured. Check operation of the valve by starting the system and switching the operation from COOLING to HEATING cycle. If the valve fails to change its position, test the voltage (24V) at the valve coil terminals (X25A) on outdoor unit PCB while the system is on the COOLING cycle. If voltage is registered at the coil, tap the valve body lightly while switching the system from HEATING to COOLING, etc. If this fails to cause the valve to switch positions, remove the coil connector cap and test the continuity of the reversing valve solenoid coil. If the coil does not test continuous - replace it. If the coil test continuous and 24 volts is present at the coil terminals, the valve is inoperative - replace it.

MBVC**00AA-1 HEATER CONTROL (OPTIONAL)

DESCRIPTION

The MBVC models utilize an electronic control that provides ECM blower motor control and control of up to two electric heat sequencers. The control has thermostat inputs for up to two stages of cooling, two stages of electric heat, reversing valve, and dehumidification. Control input is 24VAC.

All dipswitches necessary to setup cooling and electric heat airflow are fully integrated into the control.

FEATURES

The new air handler control includes advanced diagnostic features with fault recall, estimated CFM display via on-board LED, and ComfortNet™ ready. Diagnostics includes heater kit selection diagnostics, open fuse, internal control fault, data errors, and blower motor faults. Data errors are not included in the fault recall list. Diagnostic error codes are displayed on a single red LED.

The estimated CFM is displayed on an on-board green LED. The LED flashes once for each 100 CFM. The AVPEC air handlers may be used in a fully communicating ComfortNet system when matched with a compatible outdoor unit and the CTK04 thermostat. A fully communicating system offers advanced setup and diagnostic features.

BASIC OPERATION

The air handler control receives thermostat inputs from the CTK04 ComfortNet thermostat. The control operates the variable speed blower motor at the demand as determined from the thermostat input(s). If a demand for electric heat is received, the control will provide a 24VAC output for up to two electric heat sequencers.

SERVICING

TROUBLESHOOTING

MOTOR CONTROL CIRCUITS

WARNING
HIGH VOLTAGE!
Disconnect ALL power before servicing or installing. Multiple power sources may be present. Failure to do so may cause property damage, personal injury or death.



1. Turn on power to air handler or modular.

WARNING
Line Voltage now present.

2. Check voltage between pins 1 and 4 at the 4-wire motor connector on the control board. Voltage should be between 9 and 15 VDC. Replace control if voltage is not as specified.

ELECTRIC HEAT SEQUENCER OUTPUTS

WARNING
HIGH VOLTAGE!
Disconnect ALL power before servicing or installing. Multiple power sources may be present. Failure to do so may cause property damage, personal injury or death.



1. Turn on power to air handler or modular blower.

WARNING
Line Voltage now present.

2. Disconnect the 4-circuit harness connecting the control to the electric heater kit.
3. Provide a thermostat demand for low stage auxiliary heat. Measure the voltage between pins 1 and 3 at the onboard electric heat connector. Voltage should measure 24VAC. Replace control if no voltage is present.

NOTE: Allow for any built-in time delays before making voltage measurements. Any electric heater faults that are present may prevent the heater output from energizing. Verify that no heater faults are present before making voltage measurements.

4. Provide a thermostat demand for high stage auxiliary heat (W1 + W2). Measure the voltage between pins 1 and 3 at the on-board electric heat connector. Measure the voltage between pins 2 and 3 at the on-board electric heat connector. Voltage should measure 24VAC. Replace control if no voltage is present.

Communications (Applies only to Systems with Compatible ComfortNet™ Outdoor Unit and CTK04AE* Thermostat)

The integrated air handler control has some on-board tools that may be used to troubleshoot the network. These tools are: red communications LED, green receive (Rx) LED, and learn button. These are described below

- a. Red communications LED – Indicates the status of the network. Refer to the Network Troubleshooting Chart for the LED status and the corresponding potential problem.
- b. Green receive LED – Indicates network traffic. Refer to the Network Troubleshooting Chart for the LED status and the corresponding potential problem.
- c. Learn button – Used to reset the network. Depress the button for approximately 2 seconds to reset the network.

For details, see NETWORK TROUBLESHOOTING section.

WARNING
Disconnect ALL power before servicing.

AVPEC* HEATER CONTROL (OPTIONAL)

DESCRIPTION

The AVPEC* models utilize an electronic control that provides ECM blower motor control and control of up to two electric heat sequencers. The control has thermostat inputs for variable stage of cooling/heating, two stages of electric heat, reversing valve, and dehumidification. Control input is 24 VAC.

FEATURES

The new air handler control includes advanced diagnostic features with fault recall, estimated CFM display via 7 segment display of control board, CoolCloud™ and ComfortNet™ ready. Diagnostics includes heater kit selection diagnostics, open fuse, internal control fault, data errors, and blower motor faults. Data errors are not included in the fault recall list. Diagnostic error codes are displayed on a single red LED. The estimated CFM is displayed on an on-board 7 segment display. For example, if the CFM is 1240CFM, 7 segment display shows “FC...A...12...40...”.

The AVPEC* air handlers may be used in a fully communicating system when matched with a compatible outdoor unit and the thermostat. A fully communicating system offers advanced setup and diagnostic features.

BASIC OPERATION

The air handler control receives operation demand inputs from the thermostat. The control operates the variable speed blower motor at the demand as determined from the thermostat input(s). If a demand for electric heat is received, the control will provide a 24VAC output for up to two electric heat sequencers.

TROUBLESHOOTING

SERVICING

MOTOR CONTROL CIRCUITS

WARNING
HIGH VOLTAGE!
Disconnect ALL power before servicing or installing. Multiple power sources may be present. Failure to do so may cause property damage, personal injury or death.



1. Turn on power to air handler or modular.

WARNING
Line Voltage now present.

2. Check voltage between pins 1 and 4 at the 4-wire motor connector on the control board. Voltage should be between 9 and 15 VDC. Replace control if voltage is not as specified.

ELECTRIC HEAT SEQUENCER OUTPUTS

WARNING
HIGH VOLTAGE!
Disconnect ALL power before servicing or installing. Multiple power sources may be present. Failure to do so may cause property damage, personal injury or death.



1. Turn on power to air handler or modular blower.

WARNING
Line Voltage now present.

2. Disconnect the 3-circuit harness connecting the control to the electric heater kit.
3. Provide a thermostat demand for low stage auxiliary heat (W1). Measure the voltage between pins 1 and 3 at the on-board electric heat connector. Voltage should measure 24VAC. Replace control if no voltage is present.

NOTE: Allow for any built-in time delays before making voltage measurements. Any electric heater faults that are present may prevent the heater output from energizing.

Verify that no heater faults are present before making voltage measurements.

COMMUNICATIONS

The integrated air handler control has some on-board tools that may be used to troubleshoot the network. These tools are: red communications LED, green receive (Rx) LED, and learn button. These are described below

- a. Red communications LED – Indicates the status of the network. Refer to the Network Troubleshooting Chart for the LED status and the corresponding potential problem.
- b. Green receive LED – Indicates network traffic. Refer to the Network Troubleshooting Chart for the LED status and the corresponding potential problem.
- c. Learn button – Used to reset the network. Depress the button for approximately 2 seconds to reset the network. For detail see NETWORK TROUBLESHOOTING section.

WARNING
Line Voltage now present.

REFRIGERATION REPAIR PRACTICE

DANGER
Always remove the refrigerant charge in a proper manner before applying heat to the system.

When repairing the refrigeration system:

WARNING
HIGH VOLTAGE!
Disconnect ALL power before servicing or installing. Multiple power sources may be present. Failure to do so may cause property damage, personal injury or death.



1. Never open a system that is under vacuum. Air and moisture will be drawn in.
2. Plug or cap all openings.
3. Remove all burrs and clean the brazing surfaces of the tubing with sand cloth or paper. Brazing materials do not flow well on oxidized or oily surfaces.
4. Clean the inside of all new tubing to remove oils and pipe chips.
5. When brazing, sweep the tubing with dry nitrogen to prevent the formation of oxides on the inside surfaces.
6. Complete any repair by replacing the liquid line drier in the system, evacuate and charge.

BRAZING MATERIALS

Important note: Torch heat required to braze tubes of various sizes is proportional to the size of the tube. Tubes of smaller size require less heat to bring the tube to brazing temperature before adding brazing alloy. Applying too much heat to any tube can melt the tube. Service personnel must use the appropriate heat level for the size of the tube being brazed.

NOTE: The use of a heat shield when brazing is recommended to avoid burning the serial plate or the finish on the unit. Heat trap or wet rags should be used to protect heat sensitive components such as stop valves, EEV, TXV and filters.

Copper to Copper Joints - Sil-Fos used without flux (alloy

SERVICING

of 15% silver, 80% copper, and 5% phosphorous). Recommended heat 1400°F.

Copper to Steel Joints - Silver Solder used without a flux (alloy of 30% silver, 38% copper, 32% zinc). Recommended heat - 1200°F.

LEAK TESTING (NITROGEN OR NITROGEN-TRACED)



WARNING

To avoid the risk of fire or explosion, never use oxygen, high pressure air or flammable gases for leak testing of a refrigeration system.



WARNING

To avoid possible explosion, the line from the nitrogen cylinder must include a pressure regulator and a pressure relief valve. The pressure relief valve must be set to open at no more than 450 psig.

LEAK TESTING

Leak test the system using dry nitrogen and soapy water to identify leaks. If you prefer to use an electronic leak detector, charge the system to **10 PSIG** with the appropriate system refrigerant (see Serial Data Plate for refrigerant identification). Do not use an alternative refrigerant. Using dry nitrogen finish charging the system to **450 PSIG**. Apply the leak detector to all suspect areas. When leaks are discovered, repair the leaks, and repeat the pressure test. If leaks have been eliminated proceed to system evacuation.

STANDING PRESSURE TEST

Using dry nitrogen, pressurize the system to **450 PSIG**. Allow the pressure to stabilize and hold for 15 minutes (minimum). If the pressure does not drop below **450 PSIG** the system is considered leak free. Proceed to system evacuation using the Deep Vacuum Method. If after 15 minutes the pressure drops below **450 PSIG** follow the procedure outlined below to identify system leaks. Repeat the Standing Pressure Test.

SYSTEM EVACUATION



WARNING

REFRIGERANT UNDER PRESSURE!
Failure to follow proper procedures may cause property damage, personal injury or death.

IMPORTANT NOTE: Because of the potential damage to compressors, do not allow suction pressure at service valve to drop below 5 PSIG when pumping unit system down for repair. Outdoor section, depending on line set length and

amount of charge in system, may not be able to hold the entire system charge.

This is the most important part of the entire service procedure. The life and efficiency of the equipment is dependent upon the thoroughness exercised by the serviceman when evacuating air (non-condensables) and moisture from the system.

Air in a system causes high condensing temperature and pressure, resulting in increased power input and reduced performance.

Moisture chemically reacts with the refrigerant oil to form corrosive acids. These acids attack motor windings and parts, causing breakdown.

The equipment required to thoroughly evacuate the system is a vacuum pump capable of producing a vacuum equivalent to 500 microns absolute and a micron gauge to give a true reading of the vacuum in the system

NOTE: Never use the system compressor as a vacuum pump or run when under a high vacuum. Motor damage could occur.

Condensing unit liquid and suction valves are closed to contain the charge within the unit. The unit is shipped with the valve stems closed and caps installed. Do not open valves until the system is evacuated.

DEEP VACUUM METHOD

The **Deep Vacuum Method** requires a vacuum pump rated for 500 microns or less. This method is an effective and efficient way of assuring the system is free of non-condensable air and moisture. As an alternative, the **Triple Evacuation Method** may be used.

It is recommended to remove the Schrader Cores from the service valves using a core-removal tool to expedite the evacuation procedure.

Connect the vacuum pump, micron gauge, and vacuum rated hoses to both service valves. Evacuation must use both service valves to eliminate system mechanical seals.

Evacuate the system to less than 500 microns. Isolate the pump from the system and hold vacuum for 10 minutes (minimum). Typically, pressure will rise slowly during this period. If the pressure rises to less than 1000 microns and remains steady, the system is considered leak-free; proceed to system charging and startup.

If pressure rises above 1000 microns but holds steady below 2000 microns, non-condensable air or moisture may remain or a small leak is present. Return to step 2: If the same result is achieved check for leaks and repair. Repeat the evacuation procedure.

SERVICING

If pressure rises above 2000 microns, a leak is present. Check for leaks and repair. Repeat the evacuation procedure

The triple evacuation method is recommended.

1. Evacuate the system to 4000 microns and hold for 15 minutes. Then, break the vacuum with dry nitrogen, bring the system pressure up to 2-3 PSIG, and hold for 20 minutes. Release the nitrogen.
2. Evacuate to 1500 microns and hold for 20 minutes. Break the vacuum with dry nitrogen again, bring the system pressure back up to 2-3 PSIG, and hold for 20 minutes.
3. Then, evacuate the system until it is below 500 microns and hold for 60 minutes.



WARNING

Do not front seat the service valve(s) with the compressor open, with the suction line of the compressor closed or severely restricted.

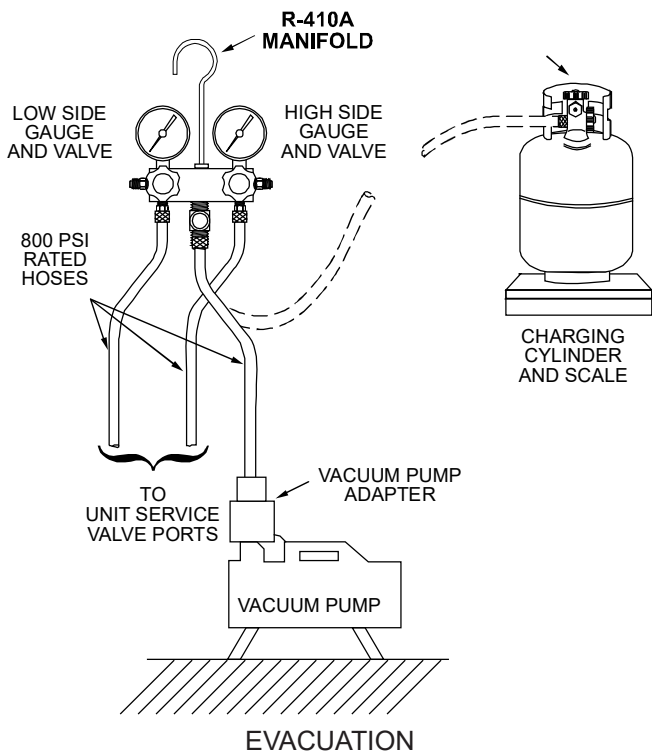

CHARGING



WARNING

REFRIGERANT UNDER PRESSURE!

- * Do not overcharge system with refrigerant.
 - * Do not operate unit in a vacuum or at negative pressure.
- Failure to follow proper procedures may cause property damage, personal injury or death.**



CAUTION

Use refrigerant certified to AHRI standards. Used refrigerant may cause compressor damage and is not covered by the warranty. Most portable machines cannot clean used refrigerant to meet AHRI Standards.



CAUTION

Damage to the unit caused by operating the compressor with the suction valve closed is not covered under the warranty and may cause serious compressor damage.

Charge the system with the exact amount of refrigerant. See the Installation Manual for the correct refrigerant charge.

An inaccurately charged system will cause future problems.

1. When using an ambient compensated calibrated charging cylinder, allow liquid refrigerant only to enter the high side.
2. Once the system stops taking refrigerant, close the valve on the high side of the charging manifold.
3. Start the system and charge the balance of the refrigerant through the low side.

NOTE: R410A should be drawn out of the storage container or drum in liquid form due to its fractionation properties, but should be "Flashed" to its gas state before entering the system. There are commercially available restriction devices that fit into the system charging hose set to accomplish this. DO NOT charge liquid R410A into the compressor.

4. With the system still running, close the valve on the charging cylinder. At this time, you may still have some liquid refrigerant in the charging cylinder hose and will definitely have liquid in the liquid hose. Reseat the liquid line core. Slowly open the high side manifold valve and transfer the liquid refrigerant from the liquid line hose and charging cylinder hose into the suction service valve port. CAREFUL: Watch so that liquid refrigerant does not enter the compressor.

FINAL CHARGE ADJUSTMENT

The outdoor temperature must be 65°F to 105°F. If outdoor ambient temperature is out of range, charge defined amount and don't adjust subcooling. Set the room thermostat to CHARGE mode.

After system has stabilized per startup instructions, check subcooling as detailed in the following section. In the event of system overcharge or undercharge, refrigerant in the system must be adjusted to the appropriate subcooling and superheat as specified in the following sections. Refrigerant amount should be adjusted within +/- 0.5 lb. if the outdoor ambient temperature is greater than 65°F and less than 105°F. Manufacturer recommends that the system should be evacuated and should be charged the initial refrigerant for given line length when the ambient temperature is less than 65°F and more than 105°F. Refer to the Installation Manual to calculate refrigerant amount.

SERVICING

5. With the system still running, remove hose and reinstall both valve caps.
6. Check system for leaks.

NOTE: Subcooling information is valid only while the unit is operating at 100% capacity or 100% of compressor speed in CHARGE MODE. Compressor speed is displayed under STATUS menu in the thermostat.

CHECKING COMPRESSOR EFFICIENCY

The reason for compressor inefficiency is that the compressor is broken or damaged, reducing the ability of the compressor to pump refrigerant vapor.

The condition of the compressor is checked in the following manner.

1. Attach gauges to the high and low side of the system.
2. Start the system and run CHARGE MODE.

If the test shows:

- a. Below normal high side pressure.
- b. Above normal low side pressure.
- c. Low temperature difference across coil.
- d. Low amp draw at compressor.

And the charge is correct. The compressor is faulty - replace the compressor.

THERMOSTATIC EXPANSION VALVE

The expansion valve is designed to control the rate of liquid refrigerant flow into an evaporator coil in exact proportion to the rate of evaporation of the refrigerant in the coil. The amount of refrigerant entering the coil is regulated since the valve responds to temperature of the refrigerant gas leaving the coil (feeler bulb contact) and the pressure of the refrigerant in the coil. This regulation of the flow prevents the return of liquid refrigerant to the compressor.

Some TXV valves contain an internal check valve thus eliminating the need for an external check valve and bypass loop. The three forces which govern the operation of the valve are: (1) the pressure created in the power assembly by the feeler bulb, (2) evaporator pressure, and (3) the equivalent pressure of the superheat spring in the valve.

0% bleed type expansion valves are used on indoor and outdoor coils. The 0% bleed valve will not allow the system pressures (High and Low side) to equalize during the shut down period. The valve will shut off completely at approximately 100 PSIG.

30% bleed valves used on some other models will continue to allow some equalization even though the valve has shut-off completely because of the bleed holes within the valve. This type of valve should not be used as a replacement for a 0% bleed valve, due to the resulting drop in performance.

The bulb must be securely fastened with two straps to a clean straight section of the suction line. Application of the bulb to a horizontal run of line is preferred. If a vertical

installation cannot be avoided, the bulb must be mounted so that the capillary tubing comes out at the top.

THE VALVES PROVIDED BY THE MANUFACTURER ARE DESIGNED TO MEET THE SPECIFICATION REQUIREMENTS FOR OPTIMUM PRODUCT OPERATION. DO NOT USE SUBSTITUTES.

OVERFEEDING

Overfeeding by the thermostatic expansion valve results in high suction pressure, cold suction line, and possible liquid slugging of the compressor.

If these symptoms are observed:

1. Check for an overcharged unit by referring to the cooling performance charts in the servicing section.
2. Check the operation of the power element in the valve as explained in Checking Thermostatic Expansion Valve
3. Check for restricted or plugged equalizer tube.

UNDERFEEDING

Underfeeding by the thermostatic expansion valve results in low system capacity and low suction pressures.

If these symptoms are observed:

1. Check for a restricted liquid line or drier. A restriction will be indicated by a temperature drop across the drier.
2. Check the operation of the power element of the valve as described in Checking Thermostatic Expansion Valve Operation.

SUPERHEAT

The thermostatic expansion valve is factory adjusted to maintain $8^{\circ}\text{F} \pm 1^{\circ}\text{F}$ degrees superheat of the suction gas. Before checking the superheat or replacing the valve, perform all the procedures outlined under Air Flow, Refrigerant Charge, Thermostatic Expansion Valve - Overfeeding, Underfeeding. These are the most common causes for evaporator malfunction.

CHECKING SUPERHEAT

Refrigerant gas is considered superheated when its temperature is higher than the saturation temperature corresponding to its pressure. The degree of superheat equals the degrees of temperature increase above the saturation temperature at existing pressure. See Temperature - Pressure Chart on following pages.

1. Run system at least 10 minutes to allow pressure to stabilize.
2. For best results, temporarily install a thermometer on the liquid line at the liquid line service valve and 4-6" from the compressor on the suction line. Ensure the thermometer makes adequate contact and is insulated for best possible readings. Use liquid line temperature to determine sub-cooling and vapor temperature to determine superheat.

SERVICING

NOTE: An optional method is to locate the thermometer at the suction line service valve. Ensure the thermometer makes adequate contact and is insulated for best possible readings.

3. Refer to the superheat table provided for proper system superheat. Add charge to lower superheat or recover charge to raise superheat.

Superheat Formula = Suct. Line Temp. - Sat. Suct. Temp.

EXAMPLE:

- a. Suction Pressure = 143 PSIG
- b. Corresponding Temp. = 50°F.
- c. Thermometer on Suction Line = 58°F.

To obtain the degrees temperature of superheat, subtract 50.0 from 58.0°F.

The difference is 8° Superheat. The 8° Superheat would fall in the ± range of allowable superheat.

CHECKING SUBCOOLING

Refrigerant liquid is considered subcooled when its temperature is lower than the saturation temperature corresponding to its pressure. The degree of subcooling equals the degrees of temperature decrease below the saturation temperature at the existing pressure.

1. Attach an accurate thermometer or preferably a thermocouple type temperature tester to the liquid service valve as it leaves the condensing unit.
2. Install a high side pressure gauge on the high side (liquid) service valve at the front of the unit.
3. Record the gauge pressure and the temperature of the line.
4. Review the technical information manual or specification sheet for the model being serviced to obtain the design subcooling.
5. Compare the hi-pressure reading to the "Required Liquid Line Temperature" chart. Find the hi-pressure value on the left column. Follow that line right to the column under the design subcooling value. Where the two intersect is the required liquid line temperature.
Alternately you can convert the liquid line pressure gauge reading to temperature by finding the gauge reading in the R-410A Pressure vs. Temperature Chart, find the temperature in the °F. Column.
6. The difference between the thermometer reading and pressure to temperature conversion is the amount of subcooling.

Add charge to raise subcooling. Recover charge to lower subcooling.

Subcooling Formula = Sat. Liquid Temp. - Liquid Line Temp.

NOTE: To adjust subcooling, follow the sequence of S-108.

EXAMPLE:

- a. Liquid Line Pressure = 417 PSIG
- b. Corresponding Temp. = 120°F.
- c. Thermometer on Liquid line = 109°F.

To obtain the amount of subcooling subtract 109°F from 120°F.

The difference is 11° subcooling. See the specification sheet or technical information manual for the design subcooling range for your unit.

There are other causes for high head pressure which may be found in the "Cooling / Heating Analysis Chart."

If other causes check out normal, an overcharge or a system containing non-condensables would be indicated.

If this system is observed:

1. Start the system.
2. Remove and capture small quantities of gas from the suction line dill valve until the head pressure is reduced to normal.
3. Observe the system while running a cooling performance test. If a shortage of refrigerant is indicated, then the system contains non-condensables.

Charging Table			
OD Ambient Temp (degF)	<65°F	65°F to 105°F	>105°F
Subcooling (degF)	Weigh in Charge	2T to 5T:8°F ±1°F	Weigh in Charge

SUPERHEAT AND SUBCOOLING ADJUSTMENT ON TXV APPLICATIONS

NOTE: Subcooling and superheat information is valid only while the unit is operating at 100% capacity or 100% compressor speed in CHARGE MODE.

Compressor speed is displayed under STATUS menu in the thermostat.

1. Run system at least 10 minutes to allow pressure to stabilize. During the adjustment of subcooling, ambient temperature should be greater than 65°F and less than 105°F. If ambient temperature is out of range, don't adjust subcooling.
2. For best results, temporarily install a thermometer on the liquid line at the liquid line service valve and 4-6" from the compressor on the suction line. Ensure the thermometer makes adequate contact and is insulated for best possible readings. Use liquid line temperature to determine sub-cooling and vapor temperature to determine superheat.

NOTE: An optional method is to locate the thermometer at the suction line service valve. Ensure the thermometer makes adequate contact and is insulated for best possible readings.

3. The system subcooling should be 8°F ± 1°F(*1). If not in that range, adjust subcooling and superheat according to the following procedure.
 - a. If subcooling and superheat are low, adjust TXV to 7 to 9°F superheat, then check subcooling.
NOTE: To adjust superheat, turn the valve stem clockwise to increase and counter clockwise to decrease.
 - b. If subcooling is low and superheat is 7 to 9°F, add charge to rise subcooling to 8°F ± 1°F(*1), then check superheat.
 - c. If subcooling is low and superheat is high, add charge

SERVICING

to rise subcooling to $8^{\circ}\text{F} \pm 1^{\circ}\text{F}(*1)$, then check superheat.

- d. If subcooling is $8^{\circ}\text{F} \pm 1^{\circ}\text{F}(*1)$ and superheat is high, adjust the TXV valve to 7 to 9°F superheat, then check subcooling.
- e. If subcooling and superheat are high, adjust the TXV valve to 7 to 9°F superheat, then check subcooling.
- f. If subcooling is high and superheat is 7 to 9°F , remove charge to lower the subcooling to $8^{\circ}\text{F} \pm 1^{\circ}\text{F}(*1)$, then check superheat.
- g. If subcooling is high and superheat is low, adjust the TXV valve to 7 to 9°F superheat and remove charge to low the subcooling to $8^{\circ}\text{F} \pm 1^{\circ}\text{F}(*1)$.
- h. If subcooling is $8^{\circ}\text{F} \pm 1^{\circ}\text{F}(*1)$ and superheat is low, adjust the TXV valve to 7 to 9°F superheat and remove charge to lower the subcooling $8^{\circ}\text{F} \pm 1^{\circ}\text{F}(*1)$, then check the superheat.

NOTE: It is recommended to add charge in 4 oz. increments each time to achieve the target subcooling.

4. Disconnect manifold set. Installation is complete.

SUBCOOLING ADJUSTMENT ON EEV APPLICATIONS

NOTE: Subcooling information is valid only while the unit is operating at 100% capacity or 100% compressor speed in CHARGE MODE.

Compressor speed is displayed under STATUS menu in the thermostat.

1. Run system at least 20 minutes to allow pressure to stabilize. During the adjustment of subcooling, ambient temperature should be greater than 65°F and less than 105°F . If ambient temperature is out of range, don't adjust subcooling.
2. For best results, temporarily install a thermometer on the liquid line at the liquid line service valve. Ensure the thermometer makes adequate contact and is insulated for best possible readings. Use liquid line temperature to determine sub-cooling.
3. The system subcooling should fall in the range shown in following table. If not in that range, adjust subcooling according to the following procedure.
 - a. If subcooling is low, add charge to adjust the subcooling to $8^{\circ}\text{F} \pm 1^{\circ}\text{F}(*1)$.
 - b. If subcooling is high, remove charge to lower the subcooling to specified range.

NOTE: It is recommended to add charge in 4 oz. increments each time to achieve the target subcooling.

4. Disconnect manifold set. Installation is complete.

CHECKING THERMOSTATIC EXPANSION VALVE

OPERATION

1. Remove the remote bulb of the thermostatic expansion valve from the suction line.
2. Start the system and cool the bulb in a container of ice water, closing the valve. As you cool the bulb, the suction pressure should fall and the suction temperature will rise.
3. Next warm the bulb in your hand. As you warm the bulb, the suction pressure should rise and the suction temperature will fall.
4. If a temperature or pressure change is noticed, the expansion valve is operating. If no change is noticed, the valve is restricted, the power element is faulty, or the equalizer tube is plugged.
5. Capture the charge, replace the valve and drier, evacuate and recharge.

NON-CONDENSABLES

If non-condensables are suspected, shut down the system and allow the pressures to equalize. Wait at least 15 minutes. Compare the pressure to the temperature of the coldest coil since this is where most of the refrigerant will be. If the pressure indicates a higher temperature than that of the coil temperature, non-condensables are present.

Non-condensables are removed from the system by first removing the refrigerant charge, replacing and/or installing liquid line drier, evacuating and recharging.

COMPRESSOR BURNOUT

When a compressor burns out, high temperature develops causing the refrigerant, oil and motor insulation to decompose forming acids and sludge.

If a compressor is suspected of being burned-out, attach a refrigerant hose to the liquid line dill valve and properly remove and dispose of the refrigerant.



NOTICE

Violation of EPA regulations may result in fines or other penalties.

Now determine if a burn out has actually occurred. Confirm by analyzing an oil sample using a Sporlan Acid Test Kit, AK-3 or its equivalent.

Remove the compressor and obtain an oil sample from the suction stub. If the oil is not acidic, either a burnout has not occurred or the burnout is so mild that a complete clean-up is not necessary.

If acid level is unacceptable, the system must be cleaned by using the clean-up drier method.

SERVICING



CAUTION

**Do not allow the sludge or oil to contact the skin.
Severe burns may result.**

NOTE: The Flushing Method using R-11 refrigerant is no longer approved by Daikin Brand Heating-Cooling.

REFRIGERANT PIPING

The piping of a refrigeration system is very important in relation to system capacity, proper oil return to compressor, pumping rate of compressor and cooling performance of the evaporator. A bi-flow filter drier must be brazed on by the installer onsite. Ensure the bi-flow filter drier paint finish is intact after brazing. If the paint of the steel filter drier has been burned or chipped, repaint or treat with a rust preventative. The recommended location of the filter drier is before the expansion device at the indoor unit. The liquid line must be insulated if more than 50 ft. of liquid line will pass through an area that may reach temperatures of 30° F or higher than ambient in cooling mode and/or if the temperature inside the conditioned space may reach a temperature lower than ambient in heating mode. FVC oils maintain a consistent viscosity over a large temperature range which aids in the oil return to the compressor; however, there will be some installations which require oil return traps. These installations should be avoided whenever possible, as adding oil traps to the refrigerant lines also increases the opportunity for debris and moisture to be introduced into the system. Avoid long running traps in horizontal suction line.

SERVICING

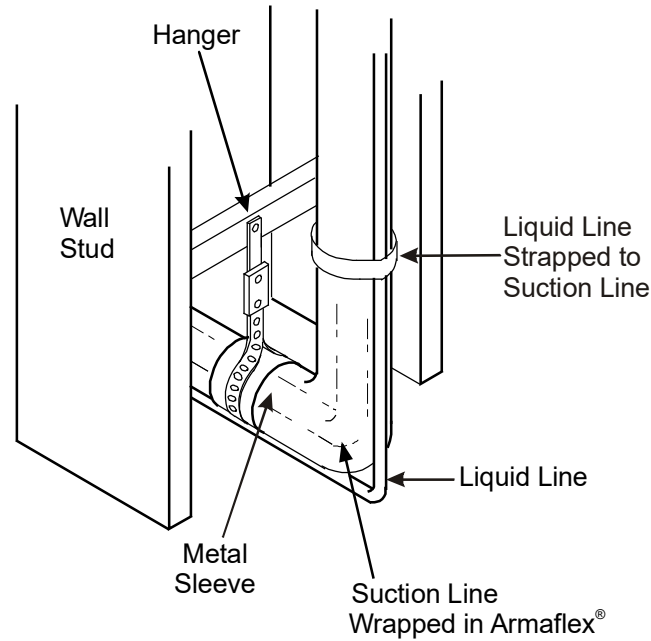

FIGURE 1-1.
INSTALLATION OF REFRIGERATION PIPING FROM VERTICAL TO HORIZONTAL

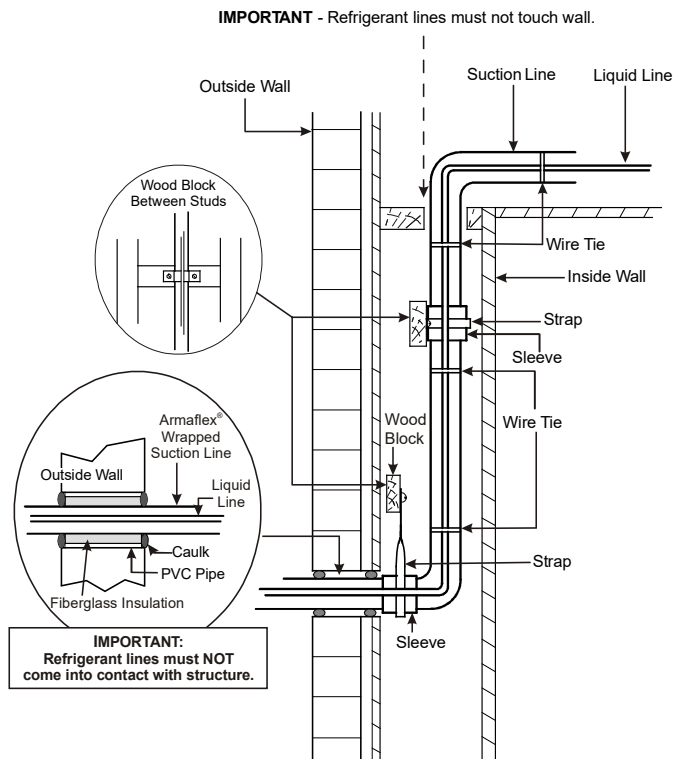
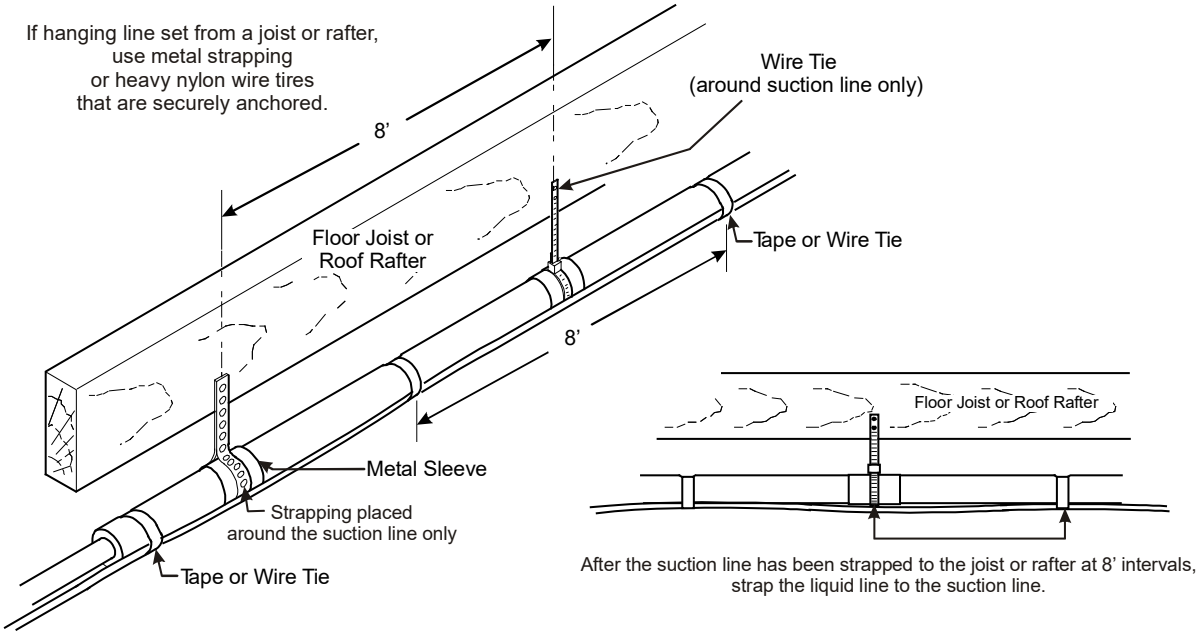

FIGURE 1-2. INSTALLATION OF REFRIGERANT PIPING (VERTICAL)
NEW CONSTRUCTION SHOWN

NOTE: If line set is installed on the exterior of an outside wall, similar installation practices are to be used.

SERVICING



SECTION 3. OUTDOOR UNIT IS ABOVE THE INDOOR UNIT



Condenser ABOVE Evaporator

Mounting the condensing unit above the evaporator coil will require an oil trap that is vertically centered between the condensing unit and air handler IF the vertical separation exceeds 80 ft. The trap can be constructed from standard refrigerant fittings as shown in the figure (bottom left).

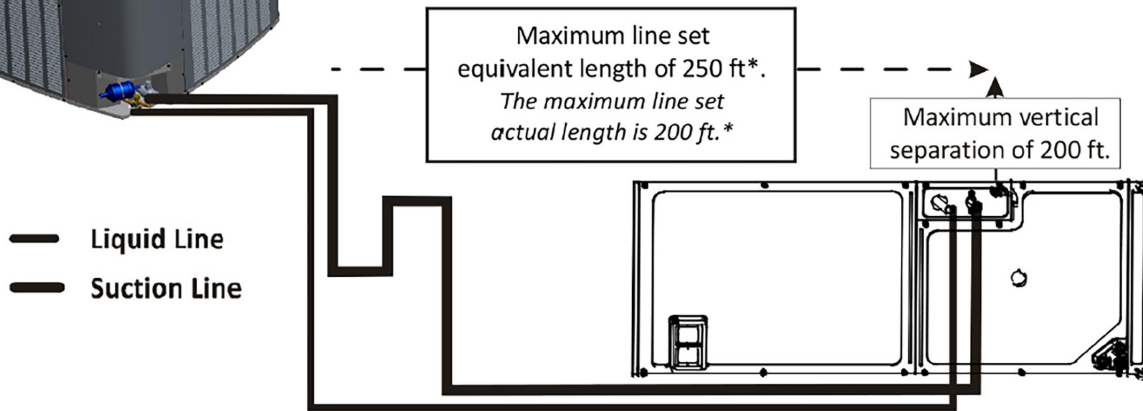

**Accounts for pressure losses of any elbows, bends, etc.*

1. Gas line must be sloped continuously towards the indoor unit.
2. The maximum elevation (vertical) difference between the outdoor unit and indoor unit is 200 feet.
3. The maximum line set equivalent length is 250 feet, which includes pressure losses of any elbow, bends, etc. The maximum line set actual length is 200 feet.
4. Inverted suction loop is not required at either unit.
5. An accumulator is not required for outdoor unit (accumulators are factory installed).

SERVICING

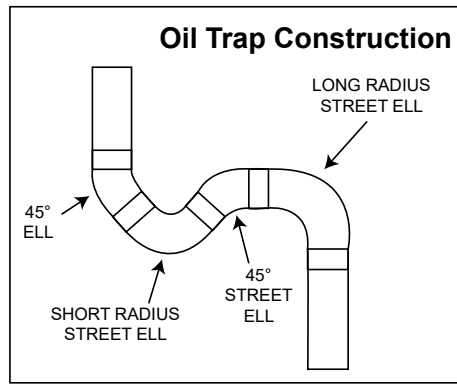

SECTION 4. OUTDOOR UNIT IS BELOW THE INDOOR UNIT

Heat Pump BELOW Indoor Coil

Mounting the indoor coil above the heat pump unit will require an inverted loop in the gas line adjacent or near the connection to the indoor coil, for the purpose of creating an oil trap. The top of the loop must be slightly higher than the top of the coil.

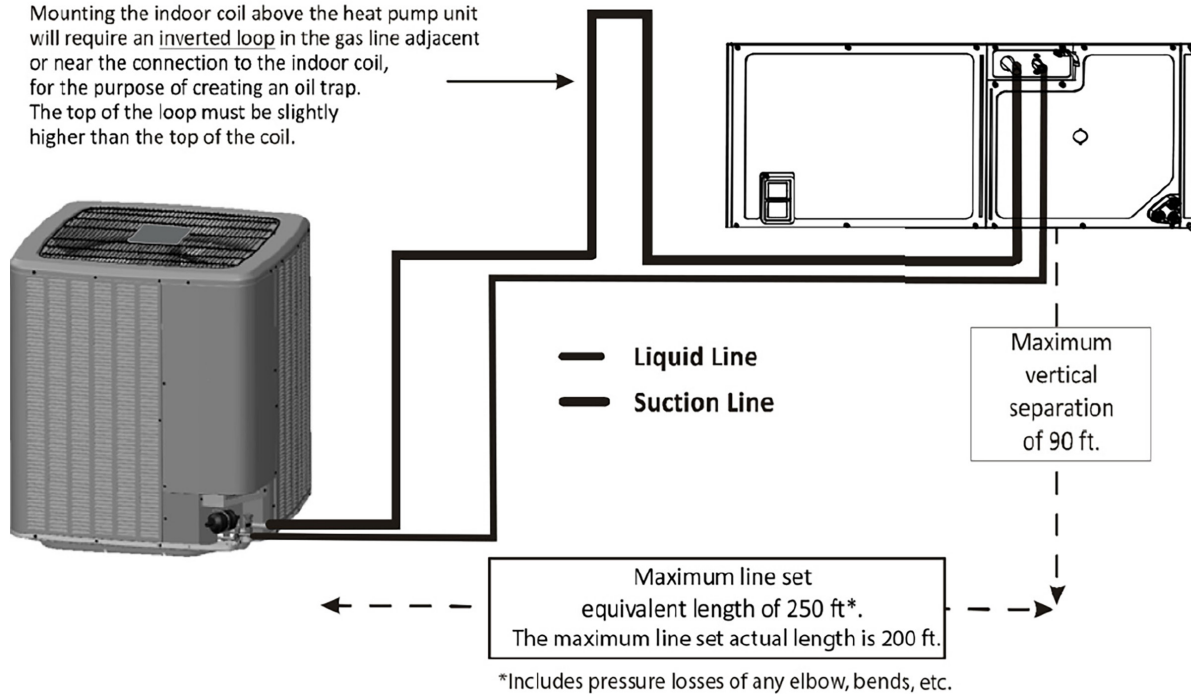

1. The maximum elevation (vertical) difference between the outdoor unit and the indoor unit is 90 feet.
2. Suction line must be installed in a manner to prevent liquid migration to the outdoor unit from the indoor unit. The heat pump condenser unit is shipped with a predetermined factory charge level as shown in the following chart. For longer line sets greater than 15 feet, add 0.6 ounces of refrigerant per foot.

NOTICE

TOTAL REFRIGERANT =
 FACTORY CHARGE + (0.6 oz./ft. * ADDITIONAL FEET
 OF ACTUAL LINE SET).

SERVICING

DUCT STATIC PRESSURES AND/OR STATIC PRESSURE DROP ACROSS COILS

This minimum and maximum allowable duct static pressure for the indoor sections are found in the specifications section.

Tables are also provided for each coil, listing quantity of air (CFM) versus static pressure drop across the coil. Too great an external static pressure will result in insufficient air that can cause icing of the coil. Too much air can cause poor humidity control and condensate to be pulled off the indoor coil causing condensate leakage. Too much air can also cause motor overloading and in many cases this constitutes a poorly designed system.

AIR HANDLER EXTERNAL STATIC

To determine proper air movement, proceed as follows:

1. Using a draft gauge (inclined manometer), measure the static pressure of the return duct at the inlet of the unit, (Negative Pressure).
2. Measure the static pressure of the supply duct, (Positive Pressure).
3. Add the two (2) readings together for total absolute value of external static pressure (for example, $-0.30''\text{wc} + 0.20''\text{wc} = 0.50''\text{wc}$ total static pressure).

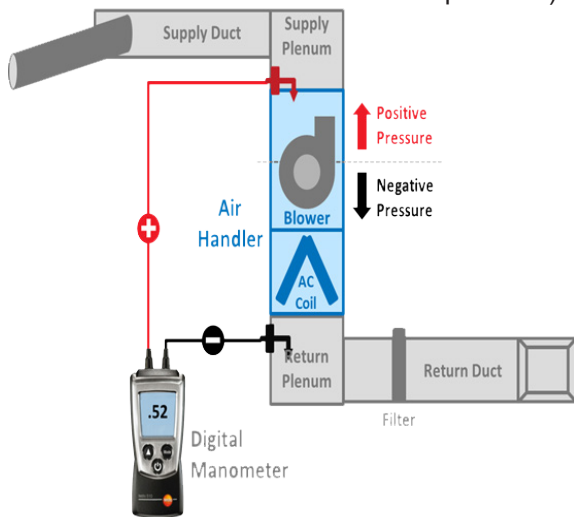

CHECKING STATIC PRESSURE SINGLE PIECE AIR HANDLER

- Measure the static pressure of the supply duct at the outlet of the air handler
 - Measure the static pressure of the return duct at the inlet of the air handler
 - Single piece air handler evaporator coil is already considered in airflow calculation
 - **NOTE:** Both readings may be taken simultaneously and read if so desired
4. Consult proper table for quantity of air.

If external static pressure is being measured on a furnace to determine airflow, supply static must be taken between the "A" coil and the furnace.

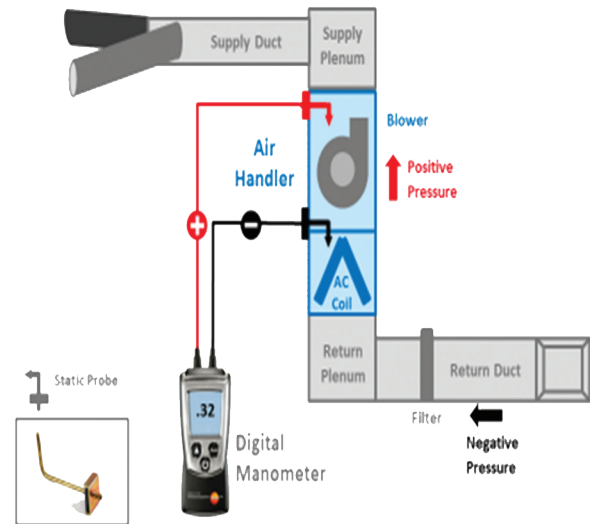

CHECKING STATIC PRESSURE ON TWO PIECE AIR HANDLER

- Measure the static pressure of the supply duct at the outlet of the unit
- Measure the static pressure between the outlet of the evaporator coil and the inlet of the air handler
- Since the evaporator coil is not part of the blower unit or furnace, *it must be not considered in calculating the static pressure of the blower unit or furnace*
- **NOTE:** Both readings may be taken simultaneously if so desired

COIL STATIC PRESSURE DROP

1. Using a draft gauge (inclined manometer), connect the positive probe underneath the coil and the negative probe above the coil.
2. A direct reading can be taken of the static pressure drop across the coil.
3. Consult proper table for quantity of air.

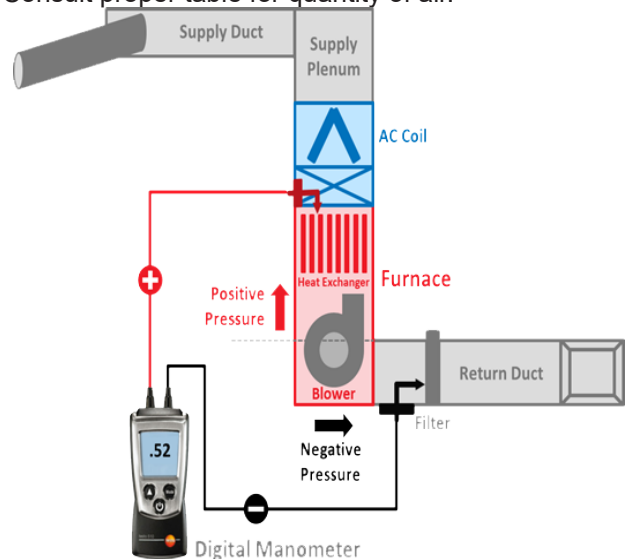

CHECKING STATIC PRESSURE FURNACE

SERVICING

- Measure static pressure of the return duct at the inlet of the furnace
- Measure the static pressure of the supply duct at the outlet of the furnace
- **NOTE:** Both readings may be taken simultaneously and read if so desired

If the total external static pressure and/or static pressure drop exceeds the maximum or minimum allowable statics, check for closed dampers, dirty filters, undersized or poorly laid out duct work.

AIRFLOW CONSIDERATION

Airflow demands are managed differently in a fully communicating system than in a non-communicating wired system. The system operating mode (as determined by the thermostat) determines which unit calculates the system airflow demand. If the indoor unit is responsible for determining the airflow demand, it calculates the demand and sends it to the ECM motor. If the outdoor unit or thermostat is responsible for determining the demand, it calculates the demand and transmits the demand along with a fan request to the indoor unit. The indoor unit then sends the demand to the ECM motor. The table below lists the various communication systems, the operating mode, and airflow demand source.

In continuous fan mode, the communicating thermostat provides the airflow demand. The communicating provides 4 continuous fan speeds (25%, 50%, 75% and 100% of maximum airflow). During continuous fan operation, the thermostat sends a fan request along with the continuous fan demand to the indoor unit. The indoor unit, in turn, sends the demand to the ECM motor. The ECM motor delivers the requested continuous fan airflow.

System	System Operating Mode	Airflow Demand Source
Any	Cooling	Outdoor Unit
	Heat Pump Heating Only	Outdoor Unit
	Continuous Fan	Thermostat
Air Handler or Modular blower	HP + Electric Heat Strips	Either outdoor unit or indoor unit, which has higher Airflow demand
	Electric Heat Strips Only	Indoor Unit
Gas Furnace	Combustion Heat	Indoor Unit

For example, assume the system is an outdoor unit matched with an indoor unit. With a call for cooling, the outdoor unit will calculate the system's cooling airflow demand. The outdoor unit will then send a fan request along with the cooling airflow demand to the indoor unit. Once received, the indoor unit will send the cooling airflow demand to the ECM motor. The ECM motor then delivers the cooling airflow.

SERVICING

INDOOR UNIT TROUBLESHOOTING FOR TXV APPLICABLE UNIT (MBVC**00AA-1)

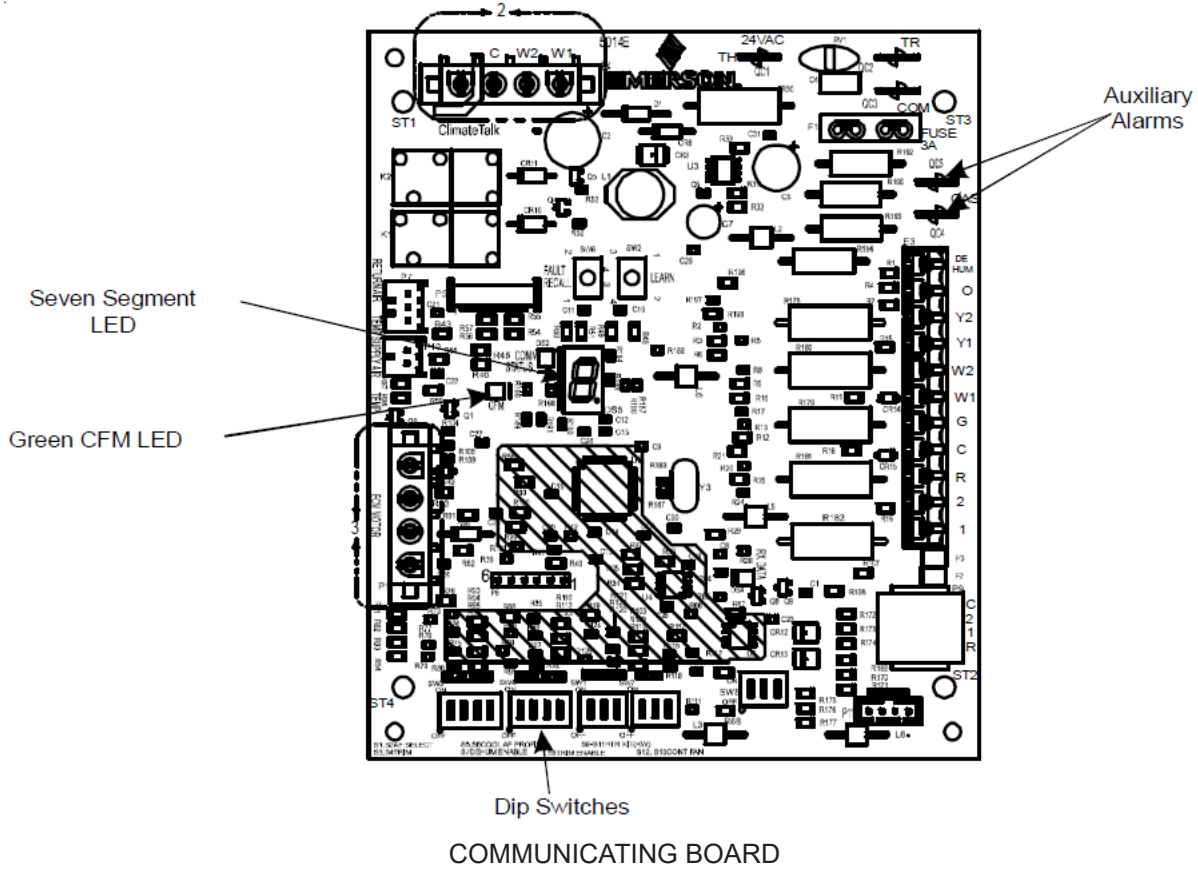

AUXILIARY ALARM SWITCH

The control is equipped with two Auxiliary Alarm terminals, labeled CAS, which are typically utilized in series with a condensate switch but could also be used with compatible CO2 sensors or fire alarms.

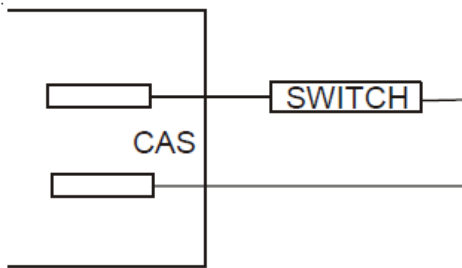

This feature can be activated or deactivated through the thermostat user menus. The auxiliary alarm switch must be normally closed and open when the alarm occurs. For example, a normally closed condensate switch will open when the base pan's water level reaches a particular level. The control will respond by turning off the blower motor and outdoor unit and displaying the proper fault codes. If the switch is later detected closed for 30 seconds, normal operation resumes and the error message is removed. The error will be maintained in the equipment's fault history. See FIGURE 15 on the following page for the connection location.

CIRCULATOR BLOWER

This air handler is equipped with a variable speed circulator blower. This blower provides several automatically-adjusted blower speeds. The Specification Sheet applicable to your model provides an airflow table, showing the relationship between airflow (CFM) and external static pressure (E.S.P.). The electric heat dip switch default position is set to the OFF, OFF, OFF position and should be adjusted by the installer to match the installation requirements for the correct electric heating CFM.

Using the Electric Heat Airflow table below, set dip switches 9, 10, and 11 for the installed heater kit. Verify selected CFM by counting the green CFM LED blinks. The green CFM LED blinks once for each 100 CFM of airflow. If an electric heater kit has not been installed, set dip switches 9, 10, and 11 to any appropriate heater kit setting (see next page table for valid settings). During the cooling operation, the outdoor unit will determine the indoor airflow.

SERVICING

INDOOR UNIT TROUBLESHOOTING FOR TXV APPLICABLE UNIT (MBVC**00AA-1)

* (Factory Setting)	19 kW or 20 kW	15 kW	10 kW	8 kW	6 kW	5 kW	3 kW
OFF ON S9 S10 S11	OFF ON S9 S10 S11	OFF ON S9 S10 S11	OFF ON S9 S10 S11	OFF ON S9 S10 S11	OFF ON S9 S10 S11	OFF ON S9 S10 S11	OFF ON S9 S10 S11
Electric Heating Air Flow (*indicates factory setting)							

NOTE: Upon start up in communicating mode the circuit board may display an “Ec” error. This is an indication that the dip switches on the control board need to be configured in accordance with the Electric Heating Airflow Table. Configuring the dip switches and resetting power to the unit will clear the error code.

Within the thermostat user menu, CTK04 communicating thermostat will display 20 kW for OFF-OFF-ON dip switch selection.

TROUBLESHOOTING

ELECTROSTATIC DISCHARGE (ESD) PRECAUTIONS

NOTE: Discharge body’s static electricity before touching unit. An electrstaic can adversely affect electrical components.

Use the following precautions during air handler installation and servicing to protect the integrated control module from damage. By putting the air handler, the control, and ther person at the same electrostatic potential, these steps will help avoid exposing the integrated control module to electrostatic discharge. This procedure is applicable to both installed and uninstalled (ungrounded) blowers.

1. Disconnect all power to the blower. Do not touch the integrated control module or any wire connected to the control prior to discharging your body’s electrostatic charge to ground.
2. Firmly touch a clean, unpainted, metal surface of the air handler blower near the control. Any tools held in a person’s hand during grounding will be discharged.
3. Service integrated control module or connecting wiring following the discharge process in step 2. Use caution not to recharge your body with static electricity; (i.e., do not move or shuffle your feet, do not touch ungrounded objects, etc.). If you come in contact with an ungrounded object, repeat step 2 before touching control or wires.
4. Discharge your body to ground before removing a new control from its container. Follow steps 1 through 3 if installing the control on a blower. Return any old or new controls to their containers before touching any ungrounded object.

DIAGNOSTIC CHART

WARNING

HIGH VOLTAGE!

TO AVOID PERSONAL INJURY OR DEATH DUE TO ELECTRICAL SHOCK, DISCONNECT ELECTRICAL POWER BEFORE PERFORMING ANY SERVICE OR MAINTENANCE.



Refer to the Troubleshooting Chart at the end of this manual for assistance in determining the source of unit operational problems. The 7 segment LED display will provide any active fault codes. An arrow printed next to the display indicates proper orientation (arrow points to top of display). See following image.



FAULT RECALL

The integrated control module is equipped with a momentary push-button switch that can be used to display the last six faults on the 7 segment LED display. The control must be in Standby Mode (no thermostat inputs) to use the feature. Depress the push-button for approximately two seconds. The LED display will then display the six most recent faults beginning with the most recent fault and decrementing to the least recent fault. The faults may be cleared by depressing the button for greater than five seconds.

NOTE: Consecutively repeated faults are displayed a maximum of three times. Example: A clogged return air filter causes the air handler’s motor to repeatedly enter a limiting condition. The control will only store this fault the first three consecutive times the fault occurs.

SERVICING

INDOOR UNIT TROUBLESHOOTING FOR TXV APPLICABLE UNIT (MBVC**00AA-1)

7 SEGMENT LED (characters will alternate)	DESCRIPTION OF CONDITION
(no display)	INTERNAL CONTROL FAULT / NO POWER
On	STANDBY, WAITING FOR INPUTS
Ec	HEATER KIT TOO LARGE, TOO SMALL, OR NO MATCH
E5	FUSE OPEN
EF	AUXILIARY SWITCH OPEN
d0	DATA NOT ON NETWORK
d1	INVALID DATA ON NETWORK
d4	INVALID Bluetooth® SHARED DATA LOADER BTSDL01 DATA
b0	BLOWER MOTOR NOT RUNNING
b1	BLOWER MOTOR COMMUNICATION ERROR
b2	BLOWER MOTOR HP MISMATCH
b3	BLOWER MOTOR OPERATING IN POWER, TEMP. ,OR SPEED LIMIT
b4	BLOWER MOTOR CURRENT TRIP OR LOST ROTOR
b5	BLOWER MOTOR ROTOR LOCKED
b6	OVER/UNDER VOLTAGE TRIP OR OVER TEMPERATURE TRIP
b7	INCOMPLETE PARAMETER SENT TO MOTOR
b9	LOW INDOOR AIRFLOW
C1	LOW STAGE COOL - LEGACY MODE ONLY
C2	HIGH STAGE COOL - LEGACY MODE ONLY
P1	LOW STAGE HEAT PUMP HEAT - LEGACY MODE ONLY
P2	HIGH STAGE HEAT PUMP HEAT - LEGACY MODE ONLY
h1	EMERGENCY HEAT LOW - COMMUNICATING MODE ONLY
h2	EMERGENCY HEAT HIGH - COMMUNICATING MODE ONLY
FC	FAN COOL - COMMUNICATING MODE ONLY
FH	FAN HEAT - COMMUNICATING MODE ONLY
F	FAN ONLY
H1	ELECTRIC HEAT LOW
H2	ELECTRIC HEAT HIGH
dF	DEFROST - COMMUNICATING MODE ONLY (Note: defrost is displayed as H1 in a legacy setup)
GREEN CFM LED-EACH FLASH REPRESENTS 10CFM (USE FOR AIRFLOW APPROXIMATION ONLY) - EXAMPLE: 8 FLASHES = 800CFM	

INDOOR UNIT TROUBLESHOOTING FOR TXV APPLICABLE UNIT (MBVC**00AA-1)

Symptoms of Abnormal Operation (Legacy & ComfortNet™ Thermostat)	7-Segment LED Codes		ComfortNet™ Thermostat Only		Possible Causes		Corrective Actions		Notes & Cautions	
	Characters	Will Alternate	Message	Code	Fault Description	Message	Code	Fault Description	Message	Code
<ul style="list-style-type: none"> LED display is ON continuously Electric heaters fail to energize on a call for W1 or Auxiliary/ Emergency heat Integrated control module LED display provides the indicated error code. ComfortNet™ thermostat "Call for Service" icon illuminated ComfortNet™ thermostat scrolls "Check Air Handler" message 	EC		<ul style="list-style-type: none"> Normal operation Heater kit selected via dipswitches is too large for heater shared data set 	None EC	<ul style="list-style-type: none"> Normal operation Heater kit selected via dipswitches is too large for heater kits in shared data set 	HTR TOO LARGE	None EC	<ul style="list-style-type: none"> Verify electric heat dipswitch set Verify the installed electric heater is valid for the air handler blower. Check nameplate or Specification Sheet applicable to your model* for allowable heater kit(s). Verify shared data set is correct for the specific model. Re-populate data using correct Bluetooth® Shared Data Loader BTSDDL01 if required. 	<ul style="list-style-type: none"> Normal operation Turn power OFF prior to repair. Use Bluetooth® Shared Data Loader BTSDDL01 for the specific model. Insert Bluetooth® Shared Data Loader BTSDDL01 BEFORE turning power ON. Bluetooth® Shared Data Loader BTSDDL01 may be removed after data is loaded. Turn power off before removing Bluetooth® Shared Data Loader BTSDDL01. 	
<ul style="list-style-type: none"> Electric heat airflow is higher than expected on a call for W1 or Auxiliary/ Emergency heat Integrated control module LED display provides the indicated error code. 	EC		<ul style="list-style-type: none"> Heater kit selected via heater kits specified in shared data set 	EC	<ul style="list-style-type: none"> Heater kit selected via dipswitches is too small for heater kits in shared data set 	HTR TOO SMALL	EC	<ul style="list-style-type: none"> Verify electric heat dipswitch set Verify the installed electric heater is valid for the air handler blower. Check nameplate or Specification Sheet applicable to your model* for allowable heater kit(s). Verify shared data set is correct for the specific model. Re-populate data using correct Bluetooth® Shared Data Loader BTSDDL01 if required. 	<ul style="list-style-type: none"> Turn power OFF prior to repair. Use Bluetooth® Shared Data Loader BTSDDL01 for the specific model. Insert Bluetooth® Shared Data Loader BTSDDL01 BEFORE turning power ON. Bluetooth® Shared Data Loader BTSDDL01 may be removed after data is loaded. Turn power off before removing Bluetooth® Shared Data Loader BTSDDL01. 	
<ul style="list-style-type: none"> Electric heat airflow is higher than expected on a call for W1 or Auxiliary/ Emergency heat Integrated control module LED display provides the indicated error code. 	EC		<ul style="list-style-type: none"> Heater kit selected via dipswitches does not match heater kits specified in shared data set 	EC	<ul style="list-style-type: none"> Heater kit selected via dipswitches is doesn't match heater kits in shared data set 	NO HTR MATCH	EC	<ul style="list-style-type: none"> Verify electric heat dipswitch set Verify the installed electric heater is valid for the air handler blower. Check nameplate or Specification Sheet applicable to your model* for allowable heater kit(s). Verify shared data set is correct for the specific model. Re-populate data using correct Bluetooth® Shared Data Loader BTSDDL01 if required. 	<ul style="list-style-type: none"> Turn power OFF prior to repair. Use Bluetooth® Shared Data Loader BTSDDL01 for the specific model. Insert Bluetooth® Shared Data Loader BTSDDL01 BEFORE turning power ON. Bluetooth® Shared Data Loader BTSDDL01 may be removed after data is loaded. Turn power off before removing Bluetooth® Shared Data Loader BTSDDL01. 	
<ul style="list-style-type: none"> Integrated control module LED display EF error code. ComfortNet™ thermostat "Call for Service". 	EF		<ul style="list-style-type: none"> Aux switch open 	EF	<ul style="list-style-type: none"> High water level in the evaporation coil. 	Aux Alarm Fault	EF	<ul style="list-style-type: none"> Check overflow pan and service 	<ul style="list-style-type: none"> Turn power OFF prior to service. 	

INDOOR UNIT TROUBLESHOOTING FOR TXV APPLICABLE UNIT (MBVC**00AA-1)

Symptoms of Abnormal Operation (Legacy & ComfortNet™ Thermostat)	7-Segment LED Codes Characters Will Alternate	Fault Description	ComfortNet™ Thermostat Only		Possible Causes	Corrective Actions	Notes & Cautions
			Message	Code			
<ul style="list-style-type: none"> Air handler blower fails to operate Integrated control module LED display provides no signal. ComfortNet™ thermostat "Call for Service" icon illuminated ComfortNet™ thermostat scrolls "Check Air Handler" message 	No Display	<ul style="list-style-type: none"> No 208/230 volt power to air handler blower or no 24 volt power to integrated control module Blown fuse or circuit breaker Integrated control module has an internal fault. 	INTERNAL FAULT	EE	<ul style="list-style-type: none"> Manual disconnect switch OFF or 24 volt wire improperly connected or loose Blown fuse or circuit breaker Integrated control module has an internal fault 	<ul style="list-style-type: none"> Assure 208/230 volt and 24 volt power to air handler blower and integrated control module. Check integrated control module fuse (3A). Replace if necessary. Check for possible shorts in 208/230 volt and 24 volt circuits. Repair as necessary. Replace bad integrated control module. 	<ul style="list-style-type: none"> Turn power OFF prior to repair. Replace integrated control module fuse with 3A automotive fuse. Replace integrated control module with correct replacement part Read precautions in "Electrostatic Discharge" section of manual.
<ul style="list-style-type: none"> Air handler blower fails to operate. Integrated control module LED display provides indicated error code. ComfortNet™ thermostat "Call for Service" icon illuminated. ComfortNet™ thermostat scrolls "Check Air Handler" message. 	d0	<ul style="list-style-type: none"> Data not yet on network. 	NO NET DATA	d0	<ul style="list-style-type: none"> Air handler blower does not contain any shared data. 	<ul style="list-style-type: none"> Populate shared data set using Bluetooth® Shared Data Loader BTSDDL01. 	<ul style="list-style-type: none"> Turn power OFF prior to repair Use Bluetooth® Shared Data Loader BTSDDL01 for the specific model. Insert Bluetooth® Shared Data Loader BTSDDL01 BEFORE turning power ON. Bluetooth® Shared Data Loader BTSDDL01 may be removed after data is loaded. Error code will be cleared once data is loaded. Turn power off before removing Bluetooth® Shared Data Loader BTSDDL01
<ul style="list-style-type: none"> Air handler blower fails to operate. Integrated control module LED display provides indicated error code. ComfortNet™ thermostat "Call for Service" icon illuminated. ComfortNet™ thermostat scrolls "Check Air Handler" message. 	d1	<ul style="list-style-type: none"> Invalid data on network. 	INVALID DATA	d1	<ul style="list-style-type: none"> Air handler blower does not contain an appropriate shared data set. 	<ul style="list-style-type: none"> Populate correct shared data set using Bluetooth® Shared Data Loader BTSDDL01. 	<ul style="list-style-type: none"> Turn power OFF prior to repair Use Bluetooth® Shared Data Loader BTSDDL01 for the specific model. Insert Bluetooth® Shared Data Loader BTSDDL01 BEFORE turning power ON. Bluetooth® Shared Data Loader BTSDDL01 may be removed after data is loaded. Error code will be cleared once data is loaded.
<ul style="list-style-type: none"> Operation different than expected or no operation. Integrated control module LED display provides indicated error code. ComfortNet™ thermostat "Call for Service" icon illuminated. ComfortNet™ thermostat scrolls "Check Air Handler" message. 	d4	<ul style="list-style-type: none"> Invalid Bluetooth® Shared Data Loader BTSDDL01 data. 	INVALID MC DATA	d4	<ul style="list-style-type: none"> Shared data set on Bluetooth® Shared Data Loader BTSDDL01 has been rejected by integrated control module 	<ul style="list-style-type: none"> Verify shared data set is correct for the specific model. Re-populate data using correct Bluetooth® Shared Data Loader BTSDDL01 if required. 	<ul style="list-style-type: none"> Turn power OFF prior to repair Use Bluetooth® Shared Data Loader BTSDDL01 for the specific model. Insert Bluetooth® Shared Data Loader BTSDDL01 BEFORE turning power ON. Bluetooth® Shared Data Loader BTSDDL01 may be removed after data is loaded. Error code will be cleared once data is loaded. Turn power off before removing Bluetooth® Shared Data Loader BTSDDL01

INDOOR UNIT TROUBLESHOOTING FOR TXV APPLICABLE UNIT (MBVC**00AA-1)

Symptoms of Abnormal Operation (Legacy & ComfortNet™ Thermostat)		7-Segment LED Codes Characters Will Alternate		Fault Description		ComfortNet™ Thermostat Only Message Code		Possible Causes		Corrective Actions		Notes & Cautions	
<ul style="list-style-type: none"> Air handler blower fails to operate. Integrated control module LED display provides indicated error code. ComfortNet™ thermostat "Call for Service" icon illuminated. ComfortNet™ thermostat scrolls "Check Air Handler" message. 	b0	<ul style="list-style-type: none"> Circulator blower motor is not running when it should be running. 	<p><i>MOTOR NOT RUN</i></p>	b0	<ul style="list-style-type: none"> Loose wiring connection at circulator motor power leads or circulator motor power leads disconnected. Failed circulator blower motor. 	<ul style="list-style-type: none"> Tighten or correct wiring connection. Check circulator blower motor. Replace if necessary. 	<ul style="list-style-type: none"> Turn power OFF prior to repair Replace circulator motor with correct replacement part. 						
<ul style="list-style-type: none"> Air handler blower fails to operate. Integrated control module LED display provides indicated error code. ComfortNet™ thermostat "Call for Service" icon illuminated. ComfortNet™ thermostat scrolls "Check Air Handler" message. 	b1	<ul style="list-style-type: none"> Integrated control module has lost communications with circulator blower motor. 	<p><i>MOTOR COMM</i></p>	b1	<ul style="list-style-type: none"> Loose wiring connection at circulator motor control leads. Failed circulator blower motor. Failed integrated control module. 	<ul style="list-style-type: none"> Tighten or correct wiring connection. Check circulator blower motor. Replace if necessary. Replace integrated control module with correct replacement part. 	<ul style="list-style-type: none"> Turn power OFF prior to repair Replace circulator motor with correct replacement part. Replace integrated control module with correct replacement part. 						
<ul style="list-style-type: none"> Air handler blower fails to operate. Integrated control module LED display provides indicated error code. ComfortNet™ thermostat "Call for Service" icon illuminated. ComfortNet™ thermostat scrolls "Check Air Handler" message. 	b2	<ul style="list-style-type: none"> Circulator blower motor horse power in shared data set does not match circulator blower motor horse power. 	<p><i>MOTOR MISMATCH</i></p>	b2	<ul style="list-style-type: none"> Incorrect circulator blower motor in air handler blower. Incorrect shared data set in integrated control module. 	<ul style="list-style-type: none"> Verify circulator blower motor horse power is the same specified for the specific air handler blower model. Replace if necessary. Verify shared data set is correct for the specific model. Re-populate data using correct Bluetooth® Shared Data Loader BTSDL01 if required. 	<ul style="list-style-type: none"> Turn power OFF prior to repair Replace motor with correct replacement part. Use Bluetooth® Shared Data Loader BTSDL01 for the specific model Insert Bluetooth® Shared Data Loader BTSDL01 BEFORE Shared Data Loader BTSDL01 may be removed after data is loaded. Error code will be cleared once shared data and motor horse power match. Turn power off before removing Bluetooth® Shared Data Loader BTSDL01 						
<ul style="list-style-type: none"> Air handler blower operates at reduced performance. Airflow delivered is less than expected. Integrated control module LED display provides b3 error code. 	b3	<ul style="list-style-type: none"> Circulator blower motor is operating in a power, temperature, or speed limiting condition. 	<p><i>MOTOR LIMITS</i></p>	b3	<ul style="list-style-type: none"> Blocked filters. Restrictive ductwork. Undersized ductwork. High ambient temperatures. 	<ul style="list-style-type: none"> Check filters for blockage. Clean filters or remove obstruction. Check ductwork for blockage. Remove obstruction. Verify all registers are fully open. Verify ductwork is appropriately sized for system. Resize/replace ductwork if necessary. See "Installation Instructions" for installation requirements. 	<ul style="list-style-type: none"> Turn power OFF prior to repair. 						
<ul style="list-style-type: none"> Air handler blower fails to operate. Integrated control module LED display provides indicated error code. ComfortNet™ thermostat "Call for Service" icon illuminated. ComfortNet™ thermostat scrolls "Check Air Handler" message. 	b4	<ul style="list-style-type: none"> Circulator blower motor senses a loss rotor control. Circulator blower motor senses high current. 	<p><i>MOTOR TRIPS</i></p>	b4	<ul style="list-style-type: none"> Abnormal motor loading, sudden change in speed or torque, sudden blockage of air handler blower/coil air inlet or outlet. High loading conditions, blocked filters, very restrictive ductwork, blockage of air 	<ul style="list-style-type: none"> Check filters, filter grills/registers, duct system, and air handler blower/coil air inlet/outlet for blockages. 	<ul style="list-style-type: none"> Turn power OFF prior to repair. 						

INDOOR UNIT TROUBLESHOOTING FOR TXV APPLICABLE UNIT (MBVC**00AA-1)

Symptoms of Abnormal Operation (Legacy & ComfortNet™ Thermostat)	7-Segment LED Codes Characters Will Alternate		ComfortNet™ Thermostat Only Message Code		Possible Causes	Corrective Actions	Notes & Cautions
	b5	b6	b5	b6			
<ul style="list-style-type: none"> Air handler blower fails to operate. Integrated control module LED display provides indicated error code. ComfortNet™ thermostat "Call for Service" icon illuminated. ComfortNet™ thermostat scrolls "Check Air Handler" message. 			MTR LCKD ROTOR	b5	<ul style="list-style-type: none"> Obstruction in circulator blower housing. Seized circulator blower motor bearings. Failed circulator blower motor. 	<ul style="list-style-type: none"> Check circulator blower for obstructions. Remove and repair/replace wheel/motor if necessary. Check circulator blower motor shaft rotation and motor. Replace motor if necessary. 	<ul style="list-style-type: none"> Turn power OFF prior to repair. Replace motor with correct replacement part. Replace wheel with correct replacement part.
<ul style="list-style-type: none"> Air handler blower fails to operate. Integrated control module LED display provides indicated error code. ComfortNet™ thermostat "Call for Service" icon illuminated. ComfortNet™ thermostat scrolls "Check Air Handler" message. 			MOTOR VOLTS	b6	<ul style="list-style-type: none"> High AC line voltage to air handler blower. Low AC line voltage to air handler blower. High ambient temperatures. 	<ul style="list-style-type: none"> Check power to air handler blower. Verify line voltage to blower is within the range specified on the air handler blower rating plate. See "Installation Instructions" for installation requirements. 	<ul style="list-style-type: none"> Turn power OFF prior to repair.
<ul style="list-style-type: none"> Air handler blower fails to operate. Integrated control module LED display provides indicated error code. ComfortNet™ thermostat "Call for Service" icon illuminated. ComfortNet™ thermostat scrolls "Check Air Handler" message. 			MOTOR PARAMS	b7	<ul style="list-style-type: none"> Error with integrated control module. Motor has a locked rotor condition. 	<ul style="list-style-type: none"> Check integrated control module. Verify control is populated with correct shared data set. See data errors above for details. Check for locked rotor condition (see error code above for details). 	<ul style="list-style-type: none"> Turn power OFF prior to repair. Replace with correct replacement part(s). Use Bluetooth® Shared Data Loader BTSDL01 for the specific model. Insert Bluetooth® Shared Data Loader BTSDL01 BEFORE turning power ON. Bluetooth® Shared Data Loader BTSDL01 may be removed after data is loaded Turn power off before removing Bluetooth® Shared Data Loader BTSDL01.
<ul style="list-style-type: none"> Air handler blower operates at reduced performance or operates on low stage when high stage is expected. Integrated control module LED display provides indicated error code. 			LOW ID AIRFLOW	b9	<ul style="list-style-type: none"> Blocked filters. Restrictive ductwork. Undersized ductwork. 	<ul style="list-style-type: none"> Check filters for blockage. Clean filters or remove obstruction. Check ductwork for blockage. Remove obstruction. Verify all registers are fully open. Verify ductwork is appropriately sized for system. Resize/replace ductwork if necessary. 	<ul style="list-style-type: none"> Turn power OFF prior to repair.

SERVICING

TROUBLESHOOTING-INDOOR UNIT FOR EEV APPLICABLE UNIT

⚠ WARNING

HIGH VOLTAGE !

DISCONNECT ALL POWER BEFORE SERVICING.

MULTIPLE POWER SOURCES MAY BE PRESENT. FAILURE TO DO SO MAY CAUSE PROPERTY DAMAGE, PERSONAL INJURY OR DEATH.



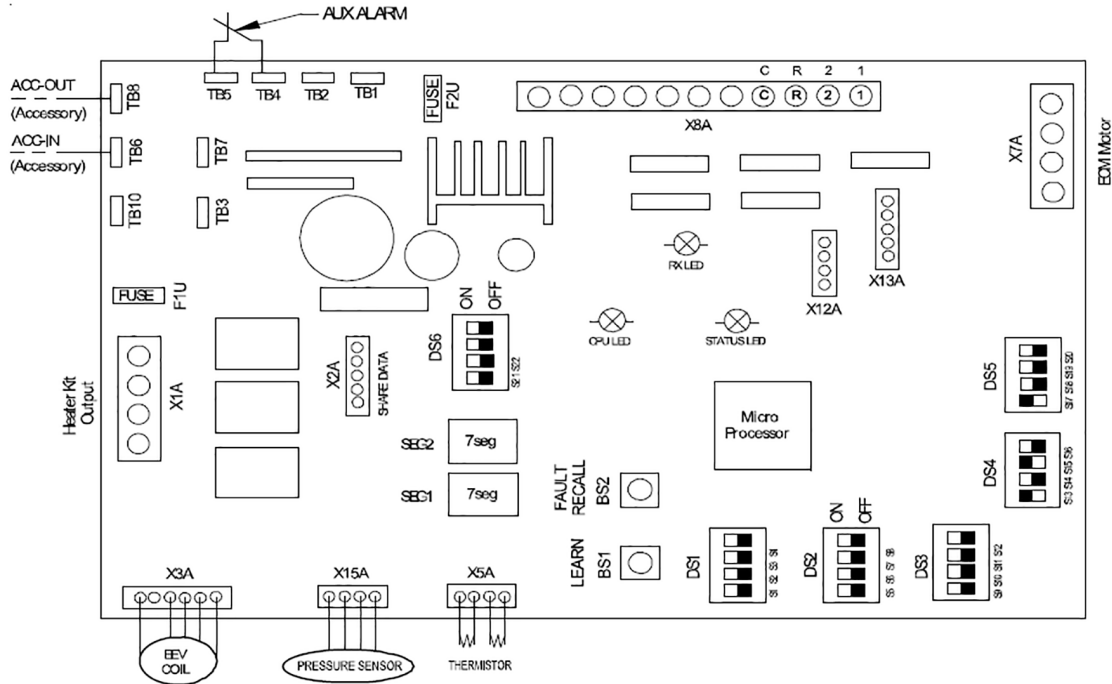

INDOOR UNIT CONTROL BOARD

AUXILIARY ALARM SWITCH

The control is equipped with two Auxiliary Alarm terminals, labeled TB4 and TB5, which are typically utilized in series with a condensate switch but could also be used with compatible CO2 sensors or fire alarms.

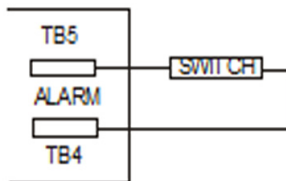

The auxiliary alarm switch must be normally closed and open when the alarm occurs. For example, a normally closed condensate switch will open when the base pan's water level reaches a particular level. The control will respond by turning off the blower motor and displaying the

proper fault codes. If the switch is later detected closed for 30 seconds, normal operation resumes and the error message is removed. The switch is closed as part of the default factory setting. The error will be maintained in the equipment's fault history.

CIRCULATOR BLOWER

This air handler is equipped with a variable speed circulator blower. This blower provides several automatically-adjusted blower speeds. The Specification Sheet applicable to your model provides an airflow table, showing the relationship between airflow (CFM) and external static pressure (E.S.P.).

SERVICING

TROUBLESHOOTING-INDOOR UNIT FOR EEV APPLICABLE UNIT

NOTE: Upon start up in communicating mode the circuit board may display an “Ed” error. This is an indication that the dip switches on the control board need to be configured in accordance with the Electric Heating Airflow Table. Configuring the dip switches and resetting power to the unit will clear the error code.

TROUBLESHOOTING

ELECTROSTATIC DISCHARGE (ESD) PRECAUTIONS

NOTE: Discharge body’s static electricity before touching unit. Electrostatics can adversely affect electrical components.

Use the following precautions during air handler installation and servicing to protect the integrated control module from damage. By putting the air handler, the control, and the person at the same electrostatic potential, these steps will help avoid exposing the integrated control module to electrostatic discharge. This procedure is applicable to both installed and uninstalled (ungrounded) blowers.

1. Disconnect all power to the blower. Do not touch the integrated control module or any wire connected to the control prior to discharging your body’s electrostatic charge to ground.
2. Firmly touch a clean, unpainted, metal surface of the air handler blower near the control. Any tools held in a person’s hand during grounding will be discharged.
3. Service integrated control module or connecting wiring following the discharge process in step 2. Use caution not to recharge your body with static electricity; (i.e., do not move or shuffle your feet, do not touch ungrounded objects, etc.). If you come in contact with an ungrounded object, repeat step 2 before touching control or wires.
4. Discharge your body to ground before removing a new control from its container. Follow steps 1 through 3 if installing the control on a blower. Return any old or new controls to their containers before touching any ungrounded object.

DIAGNOSTIC CHART

 **WARNING**

HIGH VOLTAGE!

TO AVOID PERSONAL INJURY OR DEATH DUE TO ELECTRICAL SHOCK, DISCONNECT ELECTRICAL POWER BEFORE PERFORMING ANY SERVICE OR MAINTENANCE.



Refer to the Troubleshooting Chart at the end of this manual for assistance in determining the source of unit operational problems. The 7 segment LED display will provide any active fault codes. An arrow printed next to the display indicates proper orientation (arrow points to top of display).

See following image.

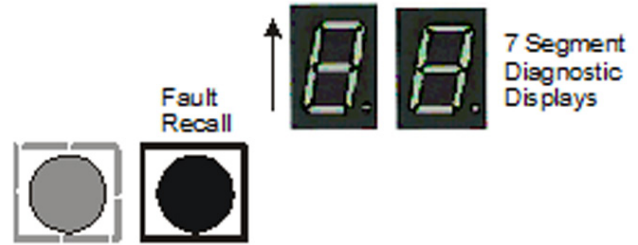

FAULT RECALL

The integrated control module is equipped with a momentary push-button switch that can be used to display the last six faults on the 7 segment LED display. To display the faults, follow the steps below.

NOTE: The integrated control module must be in Standby Mode (no thermostat inputs).

1. Press FAULT RECALL button (for 2 to 5 seconds). The 7 segment LED display will blink “--”.

NOTE: If FAULT RECALL button is not pressed long enough (for 2 to 5 seconds, the control goes back to Standby Mode. If the button is pressed for 5 to 10 seconds, control goes back to Standby Mode.

2. Release the FAULT RECALL button. The 7 segment LED display will show the most recent fault.
3. Subsequent pressing of the FAULT RECALL button will recall a previous fault. At the end of the faults, the 7 segment LED display will show “--” and go back to Standby Mode.

NOTE: Consecutively repeated faults are displayed a maximum of three times. If the FAULT RECALL button is left untouched longer than 3 minutes, the control goes back to Standby Mode.

To clear the error code history:

1. Press FAULT RECALL button until the 7 segment LED display blinks “--”.
2. Release the FAULT RECALL button. The 7 segment LED display will show “88” and clear the faults.

NOTE: If FAULT RECALL button is help pressed for longer than 15 seconds, control goes back to Standby Mode.

DIAGNOSTIC CODES

7 SEGMENT LED DISPLAY	DESCRIPTION OF CONDITION
On	Normal Operation
Eb	NO HTR KIT INSTALLED - SYSTEM CALLING FOR AUXILIARY HEAT (Minor Error Code)
Ed	HEATER KIT DIP SWITCHES NOT SET PROPERLY
E5	FUSE OPEN
EF	AUXILIARY SWITCH OPEN
d0	DATA NOT ON NETWORK
d1	INVALID DATA ON NETWORK
d4	INVALID Bluetooth™ SHARED DATA LOADER DATA
b0	BLOWER MOTOR NOT RUNNING
b1	BLOWER MOTOR COMMUNICATION ERROR
b2	BLOWER MOTOR HP (Horse power) MISMATCH
b3	BLOWER MOTOR OPERATING IN POWER, TEMP., OR SPEED LIMIT
b4	BLOWER MOTOR CURRENT TRIP OR LOST ROTOR
b6	OVER/UNDER VOLTAGE TRIP OR OVER TEMPERATURE TRIP
b7	INCOMPLETE PARAMETER SENT TO MOTOR
b9	LOW INDOOR AIRFLOW (Minor Error Code) (without EH mode)
9b	LOW INDOOR AIRFLOW (Major Error Code) (EH mode only)
70	EEV DISCONNECTION DETECTED
73	LIQUID SIDE THERMISTOR ABNORMALITY
74	GAS SIDE THERMISTOR ABNORMALITY
75	PRESSURE SENSOR ABNORMALITY
77	INDOOR UNIT - THERMOSTAT COMMUNICATION ERROR (STARTUP OPERATION & DURING OPERATION)
Hu	HUMIDIFICATION DEMAND (Running without heating)
FC	FAN COOL - COMMUNICATING MODE ONLY (Fan Demand-Cool)
FH	FAN HEAT - COMMUNICATING MODE ONLY (Fan Demand-Heat)
F	FAN ONLY (Fan Demand-Manual)
H1	ELECTRIC HEAT LOW (Heat Demand, Back-up Heat Demand)
H2	ELECTRIC HEAT HIGH (Heat Demand, Back-up Heat Demand)
dF	DEFROST - COMMUNICATING MODE ONLY (note: defrost is displayed as H1 in a legacy setup)

SERVICING

TROUBLESHOOTING-INDOOR UNIT FOR EEV APPLICABLE UNIT

2-digit 7 segment displays

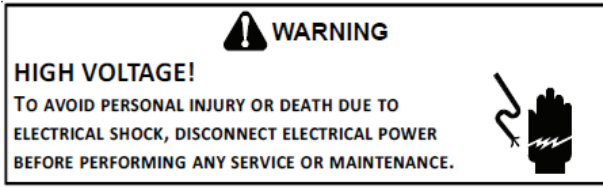

When the indoor unit is energized power supply, 2-digit 7 segment displays on indoor control board show current status of state, error code and airflow.

1. State shows current operation status of indoor unit described in right table.

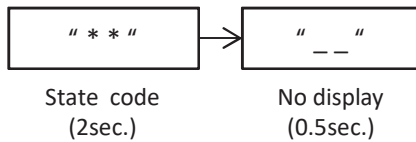

7 Segment LED Display (State)	Description of Condition
(No Display)	INTERNAL CONTROL FAULT/NO POWER
On	STANDBY, WAITING FOR INPUTS
FC	FAN COOL-COMMUNICATING MODE ONLY (Aux Heat Demand)
FH	FAN HEAT-COMMUNICATING MODE ONLY (Aux Heat Demand)
_F	FAN ONLY (Fan Demand-Manual)
H1	ELECTRIC HEAT LOW (Heat Demand, Back-up Heat Demand)
H2	ELECTRIC HEAT HIGH (Heat Demand, Back-up Heat Demand)
dF	DEFROST COMMUNICATING MODE ONLY
Hu	HUMIDITY RUNNING WITHOUT HEATING (Humidification Demand)

2. Error code shows current error indoor units have. To see the previous error code, please follow the instruction of fault recall. For more information of error code, please see the table of indoor unit error code.

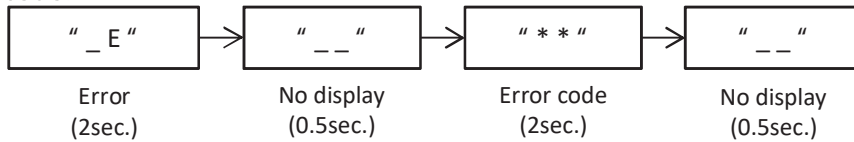

3. Airflow shows estimated CFM of indoor unit. For example, if the CFM is 1240CFM, 7 segment display shows "A...12...40...".

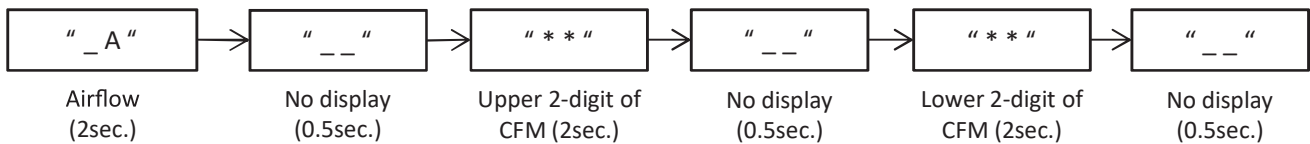

The contents indicated at 7 segment display vary from operation mode and status of indoor unit. In the event of showing some error code, please follow the instruction in the table of indoor unit error code to solve the error.

1. When the unit is running in normal mode, 2-digit 7 segment displays show state and airflow status.

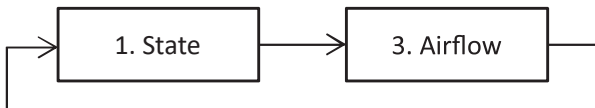

2. When the unit is having some major error code in normal mode, 2-digit 7 segment displays keep showing error code.

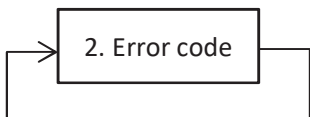

SERVICING

TROUBLESHOOTING-INDOOR UNIT FOR EEV APPLICABLE UNIT

2-digit 7 segment displays

3. When the unit is having some minor error code in normal mode, 2-digit 7 segment displays show error code and airflow status.

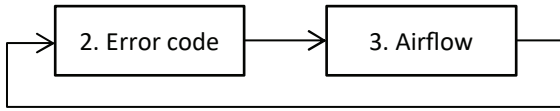

4. When the unit is having some minor error code during defrost operation in normal mode, 2-digit 7 segment displays show state "dF", error code and airflow status.

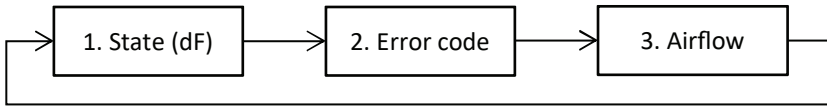

5. When the unit is having some minor error code in emergency mode, 2-digit 7 segment displays show state (EE) and error code.

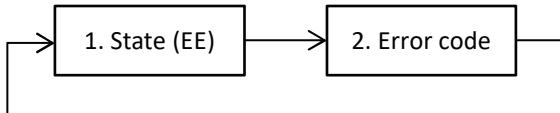

MODE DISPLAY INTRODUCTION

A 2-digit display is provided on the Control Board as a backup tool to the thermostat for accessing error codes and erasing error code history of the indoor unit. Follow the information provided in this section to learn how to use the mode display.

DISPLAY

The display consists of 2 digits.

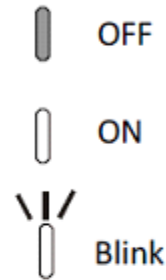
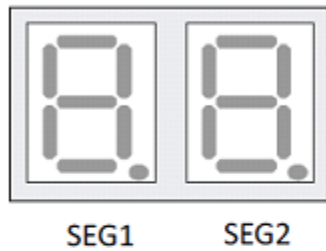

DISPLAY BUTTON LAYOUT

The display buttons shown can be used to navigate and select items:

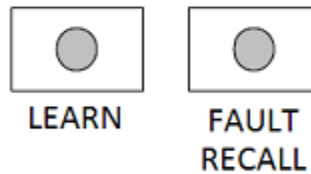

Example of button layout is shown above

FAULT CODE HISTORY NAVIGATION

This mode will allow the user to see the six most recent system faults. Please follow the flow chart to navigate to error codes from screen zero.

For a list of the fault codes, please see the TROUBLESHOOTING tables in this document.

It is also possible to erase all the diagnostics codes from this menu.

SERVICING

SETTING THE MODE DISPLAY - INDOOR UNIT

TROUBLESHOOTING-INDOOR UNIT FOR EEV APPLICABLE UNIT

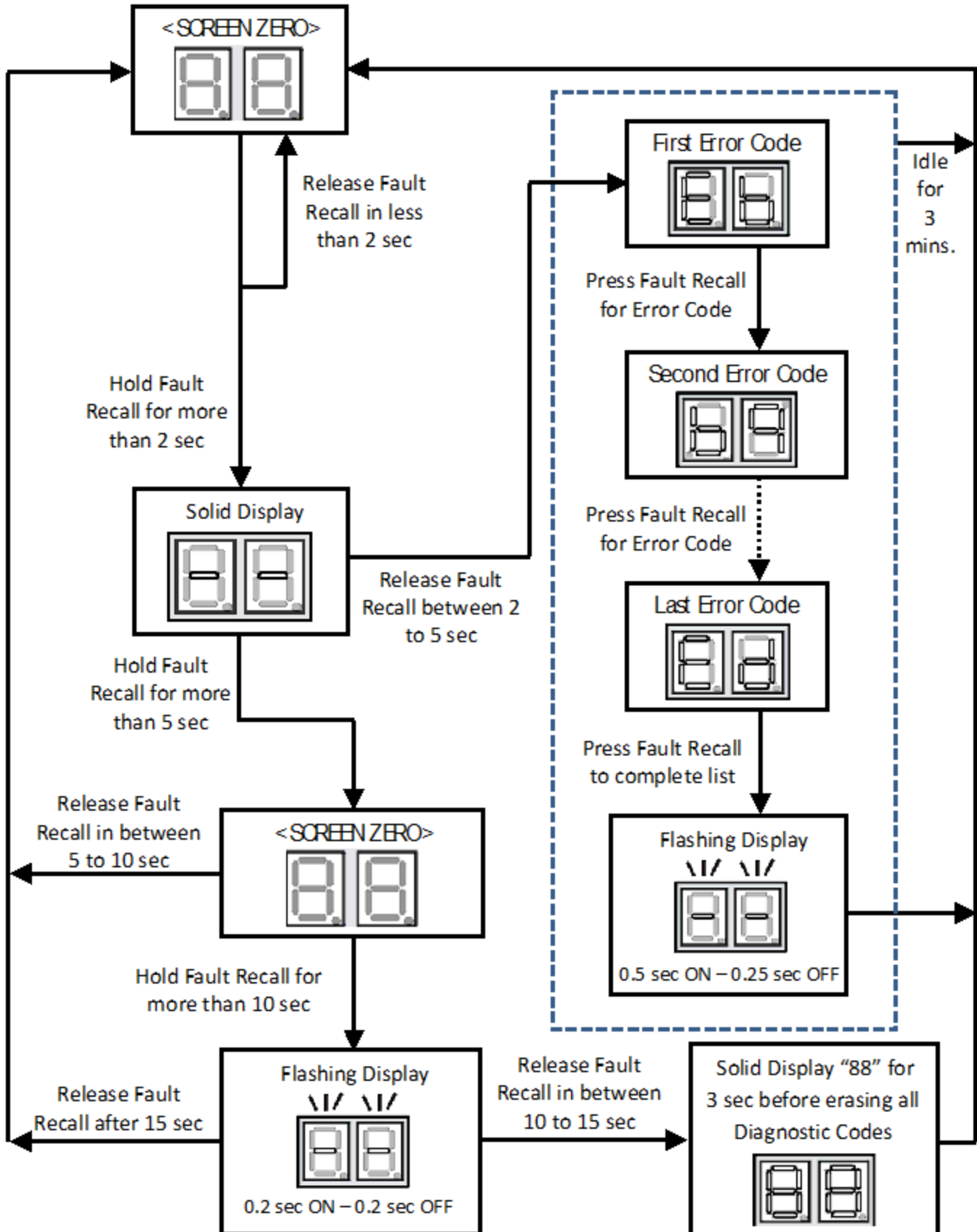

Error Code	Control Board LED Display	Transmitted Climate Talk Message *1	Description	Possible Causes	Corrective Actions
EE	No display (EE display is EMG mode)	INTERNAL FAULT	<ul style="list-style-type: none"> No power supply to ID blower / no 24 volt power to control board Blown fuse or circuit breaker Control board has an internal fault 	<ul style="list-style-type: none"> Manual disconnect switch OFF No power supply to ID blower / no 24 volt power to control board Blown fuse or faulty circuit breaker Control board has internal fault 	<ul style="list-style-type: none"> Assure 208/230 volt and 24 volt power to blower and control board. Check fuse F2U on control board Check for possible short in 208/230 volt and 24 volt circuits. Repair as necessary. Replace the control board.
Eb	E_Eb	No Display	Selecting "no heater kit" and receiving electric heat demand	<ul style="list-style-type: none"> No heater kit selected 	<ul style="list-style-type: none"> Select the valid heater kit on thermostat Valid dip switch selection (heater kit selection out of range of the unit configuration)
Ed	E_Ed	Check Heater Kit Dip Switches (CHECK HTR DIPSW)	Heater Kit dip switches not set properly	<ul style="list-style-type: none"> Invalid heater kit selected 	<ul style="list-style-type: none"> Set correct dip switches
E5	E_E5	BLOWN FUSE	Fuse Open	<ul style="list-style-type: none"> Fuse (F1U) is blown Connector TB10 is open 	<ul style="list-style-type: none"> Replace fuse Check wiring to AUX alarm, heater kit, communication connection.
EF	E_EF	Auxiliary Contacts Open (AUX ALARM FAULT)	Auxiliary Switch Open	<ul style="list-style-type: none"> High water level in the evaporation coil The connected alarm device is activated Auxiliary Alarm terminals (TB4, TB5) are open 	<ul style="list-style-type: none"> Check water level in drain pan Check alarm device. Close Auxiliary terminals TB4 and TB5 if not used
d0	E_d0	Data Not Yet On Network (NO NET DATA)	Data not on Network	<ul style="list-style-type: none"> No shared data on the network 	<ul style="list-style-type: none"> Populate shared data set using Bluetooth® Shared Data Loader BTSDL01.
d1	E_d1	Invalid Data On Network (INVALID DATA)	Invalid Data on Network	<ul style="list-style-type: none"> Wrong shared data on the network 	<ul style="list-style-type: none"> Populate shared data set using Bluetooth® Shared Data Loader BTSDL01.
d4	E_d4	Invalid Bluetooth® Shared Data Loader BTSDL01 data (INVALID MC DATA)	Invalid Bluetooth® Shared Data Loader BTSDL01 Data	<ul style="list-style-type: none"> Wrong Bluetooth® Shared Data Loader BTSDL01 data 	<ul style="list-style-type: none"> Replace circuit board Rewrite data using the correct Bluetooth® Shared Data Loader BTSDL01
b0	E_b0	Blower Motor Not Running (MOTOR NOT RUN)	Blower Motor not running	<ul style="list-style-type: none"> Fan/motor obstruction Power interruption (low voltage) Incorrect / loose wiring 	<ul style="list-style-type: none"> Check for obstruction on the fan/motor Verify the input voltage at the motor Check wiring or tighten wiring connections if needed Replace circuit board or motor
b1	E_b1	Blower Communication Error	Blower Motor Communication error	<ul style="list-style-type: none"> Incorrect / loose wiring Power interruption (low voltage) 	<ul style="list-style-type: none"> Check wiring or tighten wiring connections if needed Verify the input voltage at the motor Replace circuit board or motor
b2	E_b2	Blower Motor HP Mismatch (MOTOR MISMATCH)	Blower Motor HP Mismatch	<ul style="list-style-type: none"> Incorrect size motor Invalid shared data 	<ul style="list-style-type: none"> Correct motor installation Populate shared data set using Bluetooth® Shared Data Loader BTSDL01.
b3	E_b3	No Display	Blower Motor operating in Power, Temp or Speed Limiting conditions	<ul style="list-style-type: none"> Fan/motor obstruction or blocked filters Power interruption (low voltage) Incorrect wiring Blockage in the airflow (ductwork) or ductwork 	<ul style="list-style-type: none"> Check for obstruction on the fan/motor/ductwork, clean filters Verify the input voltage at the motor Check wiring

(*1) This message is displayed when using the CTk04 thermostat.

Error Code	Control Board LED Display	Transmitted Climate Talk Message *1	Description	Possible Causes	Corrective Actions
b4	E_b4	Blower Trip or Lost Rotor (MOTOR TRIPS)	Blower Motor - Current Trip (or) Lost Rotor	<ul style="list-style-type: none"> Fan/motor obstruction or abnormal motor loading Power interruption (low voltage) High loading conditions, blocked filters Blockage in the airflow (ductwork) or ductwork 	<ul style="list-style-type: none"> Check for obstruction on the fan/motor/ductwork Verify the input voltage at the motor Check filters, grills, duct system, coil air inlet/outlet for blockages.
b6	E_b6	Voltage or Temperature Trip (MOTOR VOLTS)	<ul style="list-style-type: none"> Blower motor stops for over/under voltage Blower motor stops due to control board over heating 	<ul style="list-style-type: none"> High AC line voltage to ID blower Low AC line voltage to ID blower High ambient temperatures Fan/motor obstruction or blockage in the airflow 	<ul style="list-style-type: none"> Verify line voltage to blower is within the range specified on the ID blower rating plate See "Installation Instructions" for installation requirements Check power to air handler blower Check for obstruction on the fan/motor/ductwork Check wiring Replace motor
b7	E_b7	Incomplete Parameters Send to Motor (MOTOR PARAMS)	ID blower motor does not have required parameters to function. Motor fails to start 40	<ul style="list-style-type: none"> Wrong / no shared data on the network Locked motor rotor condition 	<ul style="list-style-type: none"> Check for locked rotor condition (see above error code for details) Replace circuit board or motor
b9	E_b9	No Display	Low Indoor Airflow (without Electric Heat mode)	<ul style="list-style-type: none"> Fan/motor obstruction or blocked filters Restrictive ductwork or ductwork undersized ID motor failure 	<ul style="list-style-type: none"> Check for obstruction on the fan/motor Check ductwork/filter for blockage, clean filters Remove obstruction. Verify all registers are fully open Check the connections and the rotation of the motor Verify the input voltage at the motor Verify ductwork is appropriately sized for system. Resize/replace ductwork if needed Replace motor
9b	E_9b	LOW ID AIR EH MODE	Low Indoor Airflow (with Electric Heat mode)	<ul style="list-style-type: none"> Fan/motor obstruction or blocked filters Restrictive ductwork or ductwork undersized ID motor failure Combination mistake of outdoor unit and indoor unit 	<ul style="list-style-type: none"> Check for obstruction on the fan/motor Check ductwork/filter for blockage, clean filters Remove obstruction. Verify all registers are fully open Check the connections and the rotation of the motor Verify the input voltage at the motor Verify ductwork is appropriately sized for system. Resize/replace ductwork if needed Replace motor
70	E_70	EEV OPEN CKT	EEV disconnection detected	<ul style="list-style-type: none"> Indoor EEV coil not connected Incorrect wiring to EEV 	<ul style="list-style-type: none"> Check indoor EEV coil connection (Control board and junction connector) Replace EEV coil Check the resistance value of EEV coil (refer service manual)
73	E_73	LIQ TEMP FLT	Liquid side thermistor abnormality	<ul style="list-style-type: none"> Open (or) short circuit of the liquid thermistor (X5A) Liquid thermistor reading incorrect or values outside the normal range 	<ul style="list-style-type: none"> Check the connection to liquid thermistor (Control board and junction connector) Check the resistance value of the thermistor (refer service manual) Replace thermistor
74	E_74	GAS TEMP FLT	Gas side thermistor abnormality	<ul style="list-style-type: none"> Open (or) short circuit of the gas thermistor (X5A) Gas thermistor reading incorrect or values outside the normal range 	<ul style="list-style-type: none"> Check the connection to gas thermistor (Control board and junction connector) Check the resistance value of the thermistor (refer service manual) Replace thermistor
75	E_75	PRESSURE FLT	Pressure sensor abnormality	<ul style="list-style-type: none"> Open (or) short circuit of the Pressure sensor (X15A) Pressure sensor reading incorrect or values outside the normal range 	<ul style="list-style-type: none"> Check the connection to pressure sensor (Control board and junction connector) Check the output voltage of the pressure sensor (refer service manual) Replace pressure sensor Replace the control board
77 ²	E_77	No Display	Indoor Unit - Thermostat communication error (start-up & during operation)	<ul style="list-style-type: none"> Incorrect wiring between ID unit and thermostat Thermostat failure Power interruption (low voltage) 	<ul style="list-style-type: none"> Check for thermostat and indoor unit wiring Verify the input voltage at the ID unit and thermostat Replace control board or thermostat Press "LEARN" button on control board for more than 5 seconds to reestablish network

(*1) This message is displayed when using the CT/K04 thermostat.
(*2) Network communication error (Refer to "NETWORK TROUBLESHOOTING")

SERVICING

HEAT PUMP ADVANCED FEATURE MENU

HEAT PUMP / FAULT CODE HISTORY		
SUBMENU ITEM	INDICATION/USER MODIFIABLE OPTIONS	COMMENTS
ALL	(The Active and History Fault codes are displayed.)	Active fault code and up to 6 fault code histories.
ACTIVE	(The Active Fault codes are displayed.)	Active fault code only.
HISTORY	(The History Fault codes are displayed.)	Up to 6 fault code histories.
REFRESH	N/A	Selecting this menu will refresh the display.

HEAT PUMP / CONFIGURATION INFO		
SUBMENU ITEM	INDICATION/USER MODIFIABLE OPTIONS	COMMENTS
HVAC DEVICE	HEAT PUMP	The type of HVAC Device.
FIRMWARE VERSION	**	Specific number associated with the control software.
MODEL NUMBER	*VZC200*01*	This number match the model name found on the serial plate.
SERIAL NUMBER	*****	This number match the serial number found on the serial plate.

HEAT PUMP / DEVICE STATUS		
SUBMENU ITEM	INDICATION(Units)	COMMENTS
HEAT CAPACITY REQUEST	%	The request for heating. 0% means the system is off. All other values mean the system is running.
COOL CAPACITY REQUEST	%	The request for cooling. 0% means the system is off. All other values mean the system is running.
HEAT CAPACITY REQUEST DURING DEFROST	%	Indoor heat request during defrost operation. It states that additional capacity is being requested or if it is not being requested. The outdoor unit will request supplemental heating while a defrost cycle is running. 0% means defrost is not being requested and additional heating is not requested and additional heating is not required. All other values mean defrost is being requested and additional heat is being requested.
DEHUMIDIFICATION REQUEST	%	Request for dehumidification. 0% means dehumidification is not being requested. All other values mean dehumidification is being requested.
OUTDOOR FAN SPEED	RPM	Current speed of the outdoor fan in rotations per minute.
REQUESTED AIRFLOW	CFM	This is the airflow the indoor unit will try to deliver while the unit is active.
REPORTED AIRFLOW	CFM	Indoor airflow (in cubic feet per minute) as reported by the indoor unit.
BOOST MODE	OFF or ON	If this feature is available and enabled, an inverter can ramp the compressor above default speeds to increase capacity. This shows if the feature is active or inactive. To check if this function is enabled, find the Boost Mode Enable item in the setting for this unit.

HEAT PUMP / SENSOR DATA		
SUBMENU ITEM	INDICATION(Units)	COMMENTS
OUTDOOR TEMP	F	Displays the outdoor air temperature.
COIL TEMP	F	Displays the outdoor coil temperature.
LIQUID LINE TEMP	F	Displays the outdoor liquid temperature.
DISCHARGE TEMP	F	Displays the outdoor discharge temperature.
DEFROST SENSOR	F	Displays the defrost temperature.
SUCTION PRESSURE	PSI	Displays the pressure of taken slightly upstream of the suction accumulator.

A representative menu is posted. Item names and setting value are subject to change.

SERVICING

HEAT PUMP ADVANCED FEATURE MENU

HEAT PUMP / DEVICE SETTING (1)		
SUBMENU ITEM	INDICATION(Units)	COMMENTS
BOOST MODE ENABLE	OFF or ON	BOOST MODE is ON by default. See BOOST MODE section of this manual for more details.
BOOST TEMP	Always Active or 70F to 105F in increments	If enabled, when the ambient outdoor temperature is greater than this selected value, boost mode will be operational. Below this temperature the mode will not function. There is also an option to keep boost mode continuously enabled.
INDOOR/OUTDOOR HEIGHT DIFFERENCE	Both Units at Same Level, Outdoor Unit is Lower, or Indoor Unit is Lower	If the outdoor & indoor units are within +/- 15 ft. vertical distance, select SAME LEVEL. If the outdoor unit is more than 15 ft. below the indoor unit, select OUTDOOR LOWER. If the outdoor unit is more than 15 ft. above the indoor unit, select INDOOR LOWER.
RESET FOR SYSTEM SET UP	NO or YES	Selecting yes will reset any system setting to their factory defaults.
SYSTEM VERIFICATION TEST	OFF or ON	System Verification Test must be run after installation. This is approximately a 5-15 minute test. If operation mode is set to COOL mode, the system will enter CHARGE mode upon completion, otherwise it will stop.
PUMP DOWN	OFF or ON	Enter PUMP DOWN Mode. This procedure runs the equipment for approximately 15 minutes and allows accumulation of refrigerant at the outdoor unit for purposes of removing & replacing the indoor unit or outdoor unit.
ACTIVATE CHARGE MODE	OFF or ON	Enter Charging Mode. This allows for a steady system operation for a duration of approximately 1 hour to allow for refrigerant charging of the system via the charge port.
COOLING TRIM FACTOR(HIGH) ^{*1,2}	-15% to +15% in 5% increments	Select this airflow trim when inverter system is running high compressor speeds during a cooling cycle.
COOLING TRIM FACTOR(MID)	-15% to +15% in 5% increments, 20 30, Full(Max) ^{*3}	Select this airflow trim when inverter system is running mid-range (intermediate) compressor speeds during a cooling cycle.
COOLING TRIM FACTOR(LOW)	-15% to +15% in 5% increments, 20 30, Full(Max) ^{*3}	Select this airflow trim when inverter system is running low compressor speeds during a cooling cycle.
COOLING AIRFLOW PROFILE	A, B, C, or D	If it is desirable to quickly ramp up the indoor airflow select profile A. If it is desirable to reach nominal airflow quickly, but a slower ramp up time is required, select profile B. If dehumidification is required immediately when cooling mode begins select profile C. If a slower airflow ramp up / ramp down time is required in addition to dehumidification select profile D.
BLOWER ON DELAY-COOLING	5, 10, 20 or 30 Seconds	Delay between compressor turning on and indoor blower turning on during a cooling cycle.
BLOWER OFF DELAY-COOLING	30, 60, 90 or 120 Seconds	Delay between compressor shutting off and the indoor blower shutting off after a cooling cycle.

A representative menu is posted. Item names and setting value are subject to change.

*1 At Cool and Heat Hi speed trim, *VZC200601* with **VC960804C,

**VM970804C and *MVC800804C combination trim more than 5% settings are invalid. Trimmed up CFM makes miss matching error.

*2 Other than the above, depending on the connected indoor unit, there are restrictions on the positive side Trim setting.

If you want to change the Cool Airflow Trim to positive side, be sure to confirm the Airflow Trim restrictions in the latest indoor unit installation manual. The latest manual can be obtained from the website "PartnerLink(InfoFinderPlus/Literature)".

[PartnerLink URL]

<https://partnerlinkmarketing.goodmanmfg.com/goodman/info-finder-plus>

*3 The Inverter system uses lower compressor speed and lower indoor unit CFM to optimize system performance.

To obtain 100% CFM for home circulation, use full Trim setting instead of Int/Low speed.

This is recommended for applications with unusually cold return temperatures such as basements.

*4 Please refer to the page of "DEHUMIDIFICATION SELECT " for details of this function.

NOTE: The specification of *VZC200241AF, 0361AE, 0481AE and 0601AE or earlier models are different from this specification.

For details, see the Installation Manual or Service Manual that matches the Major and Minor revision of model name.

SERVICING

HEAT PUMP ADVANCED FEATURE MENU

HEAT PUMP/ DEVICE SETTING (2)		
SUBMENU ITEM	INDICATION(Units)	COMMENTS
DEHUMIDIFICATION ENABLE ⁴	Standard, OFF, A, B or C	Selecting "OFF" disables dehumidification selecting. "Standard", "A", "B" or "C" enables dehumidification.
RESET COOLING SETTINGS	NO or YES	Selecting yes will reset any cooling setting to their factory defaults.
RPS RANGE FOR COOLING	**.* to *.* RPS,...(Total 5 Ranges)	When determining the appropriate compressor speed for cooling, select the range that contains the desired value. The Selected RPS for Cooling menu is where you will select your desired value within this selected range.
SELECTED RPS FOR COOLING	*.* RPS	This value will be a number inside the RPS Range for Cooling. If you'd like to select a RPS from a different range, you must change the RPS Range for Cooling setting first, then restart the device setting page.

A representative menu is posted. Item names and setting value are subject to change.

*1 At Cool and Heat Hi speed trim, *VZC200601* with **VC960804C,

**VM970804C and *MVC800804C combination trim more than 5% settings are invalid. Trimmed up CFM makes miss matching error.

*2 Other than the above, depending on the connected indoor unit, there are restrictions on the positive side Trim setting.

If you want to change the Cool Airflow Trim to positive side, be sure to confirm the Airflow Trim restrictions in the latest indoor unit installation manual.

The latest manual can be obtained from the website "PartnerLink(InfoFinderPlus/Literature)".

[PartnerLink URL]

<https://partnerlinkmarketing.goodmanmfg.com/goodman/info-finder-plus>

*3 The Inverter system uses lower compressor speed and lower indoor unit CFM to optimize system performance.

To obtain 100% CFM for home circulation, use full Trim setting instead of Int/Low speed.

This is recommended for applications with unusually cold return temperatures such as basements.

*4 Please refer to the page of "DEHUMIDIFICATION SELECT " for details of this function.

NOTE: The specification of *VZC200241AF, 0361AE, 0481AE and 0601AE or earlier models are different from this specification.

For details, see the Installation Manual or Service Manual that matches the Major and Minor revision of model name.

SERVICING

EMERGENCY MODE FOR EEV APPLICABLE INDOOR UNIT



Emergency mode is to only be used in a situation where communication between equipment (broken wires) or a failed thermostat cannot be immediately corrected or replaced. This mode will allow for cooling or heating to be activated without the need of communication wires or a thermostat. Once corrections have been made to wiring or the thermostat, emergency mode must be turned off and the system returned to normal operation (this applies to both the indoor and outdoor units). Note: Emergency mode does not control to a specific room temperature set point. Exact room temperature achieved is related to the building load at the time emergency mode is activated. This is only a temporary solution.

At first inspection, if the outdoor unit is displaying one of the following error codes: E51 (outdoor communication error), Eb0 (no indoor airflow), Eb9 (low indoor airflow), Ed2 (Indoor unit is too small and cannot provide airflow of outdoor unit) or the indoor unit is displaying error code E77 (no thermostat communications) it is acceptable to use emergency mode if the equipment cannot be immediately fixed. Cycling power to the equipment may temporarily clear error codes, but doing so may not fix the underlying problem. Note: If after initial power up communication issues occur due to faulty wires or a thermostat these error codes may not be displayed.

In emergency mode, the unit will function according to the mode selected on the appropriate dip switches. Operation in emergency mode must be limited to a minimum and should be viewed as a temporary solution before the issue with the unit is resolved and system operates in normal mode.

NOTE: In the emergency operation, the operating status will not be shown in the thermostat status menu or on the outdoor 7-segment displays. The 7-segment displays on indoor control board will display “EE”.

1. HEATING EMERGENCY MODE

Emergency Heating mode is to be used when communication between the indoor unit and thermostat is not functioning properly. This mode will run the electric heat strips independently of any thermostat in one of two modes: High Heat Level or Low Heat Level. Dip Switch Bank DS-6 (specifically dip switches S-21 and S-22) on the indoor control is used to engage emergency heating mode. Default setting for these two dip switches are in the OFF position (S21 set to ON and S22 set to ON will enable Low Heat Level Emergency Mode. S21 set to OFF and S22 set to ON will enable High Heat Level Emergency Mode). Note: once equipment has been fixed, these dip switches must be placed back in the OFF position. During operation, the indoor fan and electric heater kit will be turned on and off at following intervals based on the Heat Level selected. 2 stage electric heater kits will be energized in stage 2.

	Heating On	Heating Off
High Heat Level	8 minutes	8 minutes
Low Heat Level	7 minutes	15 minutes

Emergency Heat Mode Airflow: DIP switches S-9, S-10, S-11 and S-12 must be set to the correct size electric heat kit that has been installed. These are located on dip switch bank DS-3 of the indoor control. See the Switch Bank DS-3 Indoor Control Board Settings table to properly select heater kit size.

To activate heating emergency mode, appropriately select switches S-21 and S-22 from dip switch bank DS-6 on the indoor control board depending on the heat level required in accordance with the Switch Bank DS-6 Indoor Control Board Settings table.

NOTE: During the heating emergency mode, outdoor unit must stop operation. Once the communication is established, heating emergency mode must be terminated so that the system resumes operation in normal mode. To eliminate the heating emergency mode, dip switches S-21 and S-22 from dip switch bank DS-6 on the indoor control board must be set back to default factory settings (normal operating mode).

SERVICING

Upon start up in emergency mode the circuit board may display an “Ed” error. This is an indication that the DIP switches on the control board need to be configured in accordance with the Electric Heating Airflow Table. Configuring the DIP switches to the unit will clear the error code.

Switch Bank DS-3 Indoor Control Board Settings								
Heater Kit Selection	Heater kW				Dip Switch Setting			
	AVPEC25B14	AVPEC37C14	AVPEC59D14	AVPEC61D14	S-9	S-10	S-11	S-12
No Heater	-	-	-	-	OFF*	OFF*	OFF*	OFF*
First	3	5	5	5	ON	ON	ON	ON
Second	5	6	6	6	ON	ON	ON	OFF
Third	6	8	8	8	ON	ON	OFF	ON
Fourth	8	10	10	10	ON	ON	OFF	OFF
Fifth	10	15	15	15	ON	OFF	ON	ON
Sixth	X	19	20	20	ON	OFF	ON	OFF
Seventh	X	X	X	25	ON	OFF	OFF	ON

Switch Bank DS-6 Indoor Control Board Settings				
Function			S-21	S-22
Normal operation			OFF*	OFF*
Emergency Mode	Cooling Emergency mode/Fan only Emergency mode		ON	OFF
	Heating Emergency mode (High heat level)		OFF	ON
	Heating Emergency mode (Low heat level)		ON	ON

Switch Bank DS-2 Outdoor Control Board Settings				
Function			S-1	S-2
Normal operation			ON*	ON*
Emergency Mode	Cooling Emergency mode (Low cool Level)		ON	OFF
	Cooling Emergency mode (Medium cool Level)		OFF	ON
	Cooling Emergency mode (High cool level)		OFF	OFF

NOTE: Default factory settings are marked with *.

SERVICING

2. COOLING EMERGENCY MODE

Cooling emergency mode is to be used when communication between the indoor and outdoor units is not functioning properly and temporary cooling operation is required. This mode enables the outdoor unit and indoor unit to run independently of each other. There are two key steps to setup Cooling Emergency Mode.

- Select the appropriate airflow on the indoor unit and enable emergency indoor airflow operation (using Dip switches S-13 and S-14 of Switch Bank DS-4 on the indoor unit to select desired 25%, 50%, 75% or 100% airflow. In addition, set switch bank DS-6 dip switches S-21 to ON and S-22 to OFF enabling emergency indoor fan).
- Select the desired cooling level at the outdoor unit (there are 3 levels available: Low Cool Level, Medium Cool Level, High Cool Level selectable by dip switch bank DS-2 on the outdoor unit). See Dip Switch Position DS2-1 and DS2-2 Table for cooling level selection.

Switch Bank DS-4 Indoor Fan Settings					
Function	Value	SW13	SW14	SW15	SW16
Fan Only Speed %	25	OFF	OFF	-	-
	50	ON*	OFF*	-	-
	75	OFF	ON	ON*	-
	100	ON	ON	OFF	-

During operation the indoor unit will provide constant airflow as selected (even if the compressor has stopped). The indoor unit will continue to operate the electronic expansion valve for refrigerant super heat control and the compressor will cycle at the interval selected by dip switch bank DS-2

Dip Switch Position		Function
DS2-1	DS2-2	
ON	ON	Normal Operation
ON	OFF	Emergency Mode (Low Cool Level)
OFF	ON	Emergency Mode (Medium Cool Level)
OFF	OFF	Emergency Mode (High Cool Level)

	ON time	OFF time	Avg. Run Time
Low Cool Level	7 minutes	15 minutes	30%
Medium Cool Level	8 minutes	10 minutes	50%
High Cool Level	15 minutes	6 minutes	70%

Note: This mode does not require a thermostat. Any thermostat requests will be ignored while in emergency operation.

NOTE: Set indoor DS-4 (Indoor fan setting) and DS-6 (Indoor emergency mode enable) before setting outdoor DS-2 dip switch settings. Otherwise, the compressor may be damaged in operation.

Note: When proper communication is established, these switches must be returned to default settings

The compressor speed will automatically adjust based on the outdoor ambient temperature. If ambient temperature is higher than 95 ° F, the outdoor unit can operate at 100% compressor speed. If ambient temperature is lower than 70° F, the unit will run at 50% compressor speed. Between 95 ° F and 70 ° F, the compressor speed will adjust linearly as shown.

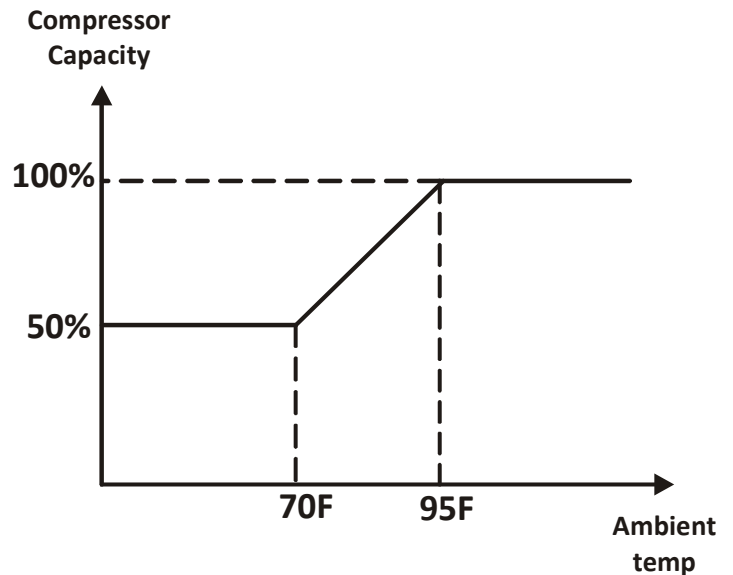

SERVICING

TROUBLESHOOTING- OUTDOOR UNIT AND INDOOR UNIT FOR EEV APPLICABLE UNIT

Dipswitch Default Factory Settings			
Switch #		Setting	Function
ID DS-1	1	OFF	No Use
	2	OFF	No Use
	3	OFF	No Use
	4	OFF	No Use
ID DS-2	5	OFF	No Use
	6	OFF	No Use
	7	OFF	No Use
	8	OFF	No Use
ID DS-3	9	OFF	Heater Kit Selection in Emergency Mode
	10	OFF	Heater Kit Selection in Emergency Mode
	11	OFF	Heater Kit Selection in Emergency Mode
	12	OFF	Heater Kit Selection in Emergency Mode
ID DS-4	13	ON	Allow in Emergency Mode (Fan Emergency Mode)
	14	OFF	Allow in Emergency Mode (Fan Emergency Mode)
	15	ON	EEV Enable**
	16	OFF	No Use
ID DS-5	17	ON	Emergency EEV Opening
	18	OFF	Emergency EEV Opening
	19	OFF	EEV Emergency Mode**
	20	OFF	No Use
ID DS-6	21	OFF	Emergency mode (Cooling and Heating Emergency Mode)
	22	OFF	Emergency mode (Cooling and Heating Emergency Mode)
	23	OFF	No Use
	24	OFF	No Use
OD DS-1	1	ON	CT Communication Enable*
	2	ON	CT Communication Enable*
OD DS-2	1	OFF	Cooling Emergency mode*
	2	OFF	Cooling Emergency mode*

* Must be set at factory setting to operate the normal mode.

** Must be set at factory setting indoor unit with EEV. It's prohibited to change setting.

SERVICING

COOLING EMERGENCY MODE WIRING FOR TXV APPLICABLE INDOOR UNIT

Cooling emergency mode is available when using a TXV applicable indoor unit. To energize the blower at the appropriate speed, standard Legacy wiring is required. The image below shows how the thermostat input terminals are to be wired when selecting a cooling airflow. Note: the blower will run continuously with this wiring which is required. The outdoor unit will cycle as described in the Cooling Emergency Mode section when appropriate dip switch modes are set.

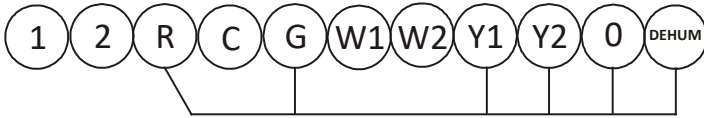

INDOOR UNIT INTEGRATED CONTROL MODULE

Note: Emergency heating mode is not available with TXV applicable indoor units. If communications still exist between the indoor unit and thermostat, the thermostat should be used to provide heating calls.

MODE DISPLAY INTRODUCTION

A 3-digit display is provided on the Control board as a backup tool to the thermostat for reading faults, fault history, monitoring and setting up the unit. Follow the information provided in this section to learn how to use the mode display.

DISPLAY

The display consists of 3 digits.

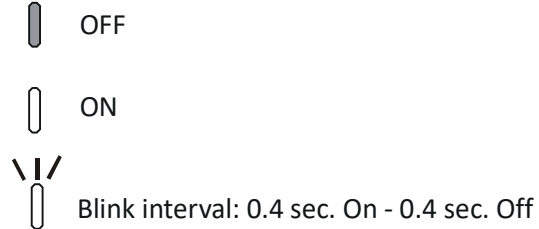
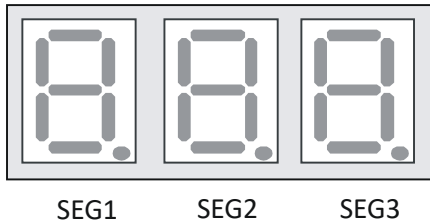

DISPLAY BUTTON LAYOUT

The display buttons shown can be used to navigate and select items:

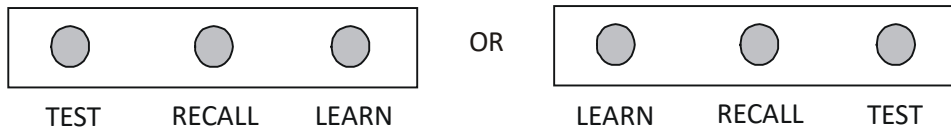

*Examples of button layout are shown above.
 Identify correct display buttons on your unit Control board.*

MODES

There are 5 modes which can be accessed using the setting display: FAULT CODE, FAULT HISTORY, MONITORING, SETTING MODE 1 and SETTING MODE 2.

To enter any of these modes, use the schemes shown in this section. Each mode has its own corresponding "Screen #" within the display itself which allows the user to navigate and use the features. (Example: The Fault Code is accessed and displayed from "Screen 0" of the 7-segment display. The Fault History is accessed and display using "Screen 1" of the display, etc.)

<u>MODE</u>	<u>FUNCTION</u>	<u>DISPLAY SCREEN #</u>
<i>Fault Code Display</i>	Present fault (if any).	0 (Default)
<i>Fault Code History</i>	6 Recent faults stored.	1
<i>Monitoring Mode</i>	*Monitors system values.	2
<i>Setting Mode 1</i>	*Can change system settings	3
<i>Setting Mode 2</i>	*Can change system settings.	4

**See tables at the end of this section.*

NAVIGATING THROUGH THE DISPLAY SCREENS

- SCREEN 0** The home or default screen on the display. This shows the most recent fault.
- SCREEN 1** To access, hold the RECALL button for 5 seconds at screen 0.
- SCREEN 2** To access, hold the RECALL button for 5 seconds at screen 1.
- SCREEN 3** To access, hold the RECALL button for 5 seconds at screen 2.
- SCREEN 4** To access, hold the RECALL and TEST buttons simultaneously for 5 seconds at screen 2.
To return to SCREEN 0 of the display, press the LEARN button.

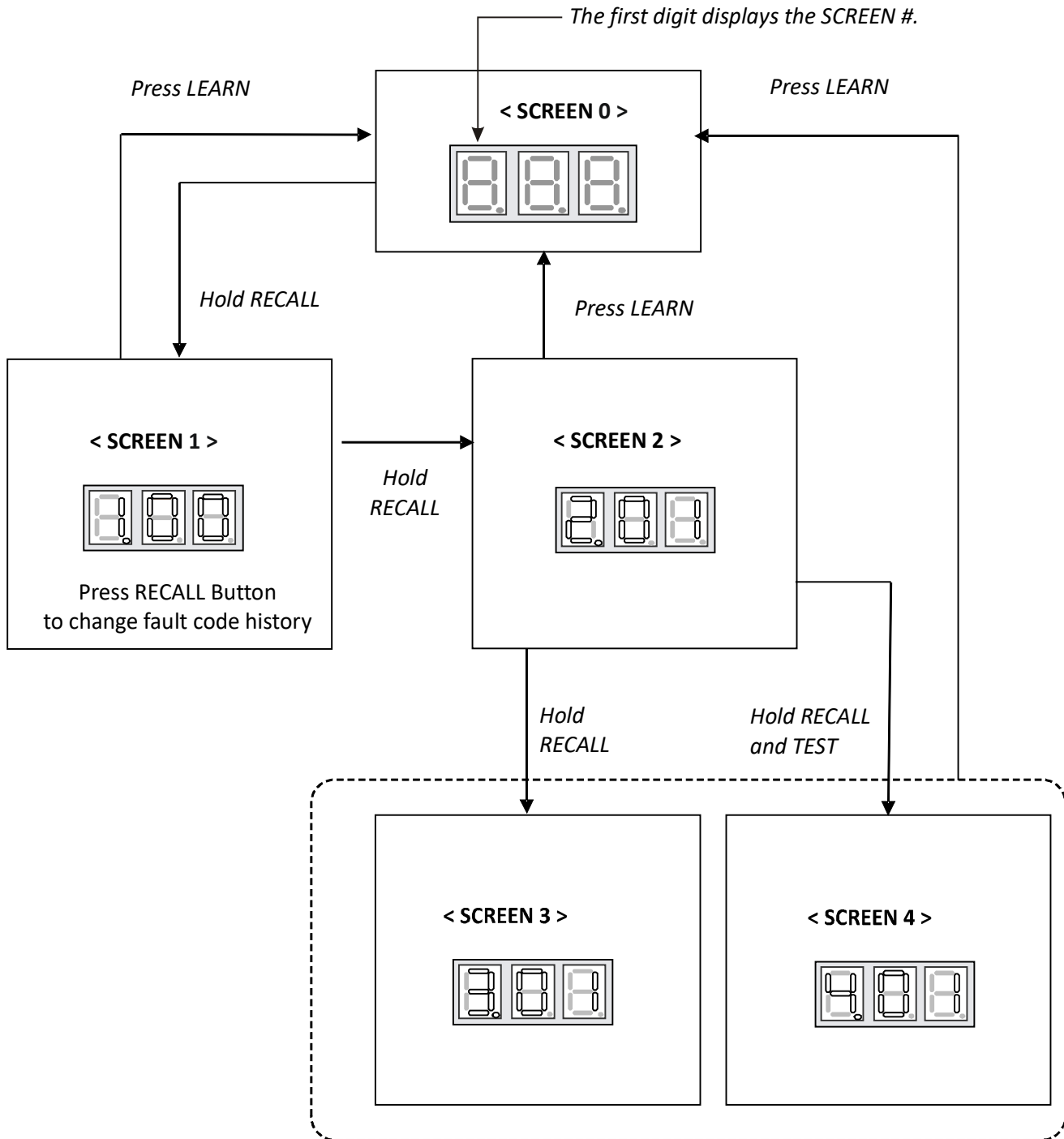

FAULT CODE HISTORY NAVIGATION

< SCREEN 1 >

This mode will allow the user to see the six most recent system faults.

For a list of the fault codes, please see the TROUBLESHOOTING tables in this document.

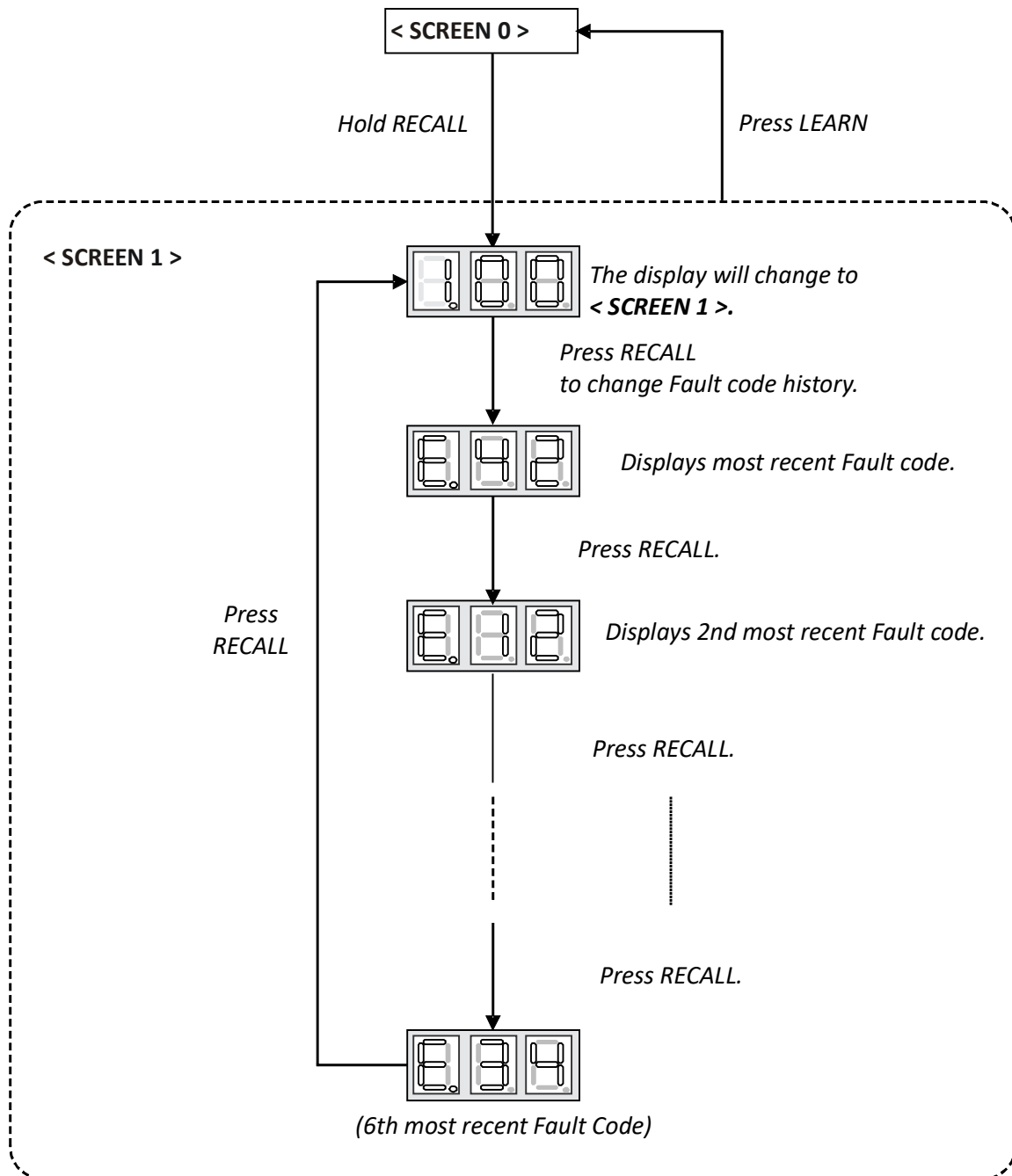

MONITORING MODE NAVIGATION

< SCREEN 2 >

This screen allows the user to monitor system variables as shown in the tables at the end of this section.

< SCREEN 0 >

OFF

ON



Blink interval:
0.4 sec. On - 0.4 sec. Off

< SCREEN 1 >

Hold RECALL

Press LEARN

< SCREEN 2 >

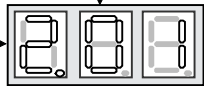

Press RECALL
to increase the value.

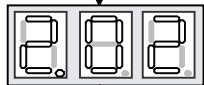

Press RECALL.



Press RECALL.

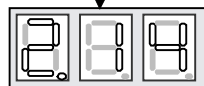

Press TEST
to confirm the setting.

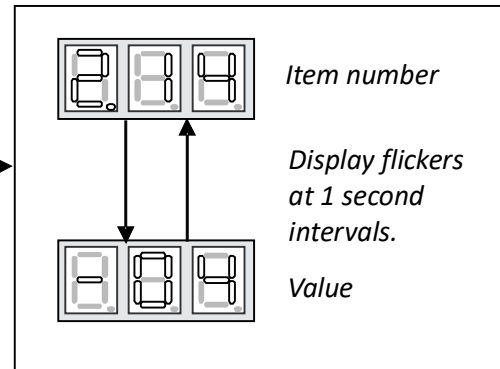

Press RECALL.

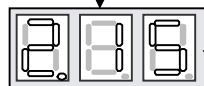

Press RECALL.

Press
RECALL

SETTINGS MODE 1 NAVIGATION

< SCREEN 3 >

Setting Mode 1 allows the user to adjust system settings as shown in the tables at the end of this section.

< SCREEN 0 >

OFF

ON



Blink interval:

0.4 sec. On - 0.4 sec. Off

< SCREEN 2 >

Hold RECALL.

Press LEARN.

< SCREEN 3 >

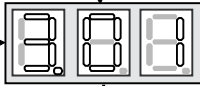

Press RECALL to increase the value.

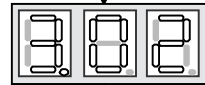

Press RECALL.

.....

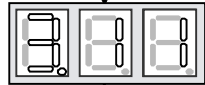

Press RECALL.

Press TEST to change setting.

Press RECALL.

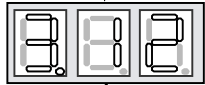

< Changing Setting Display >

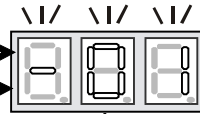

Press RECALL to increase the value.

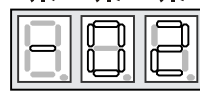

Press TEST.

Press RECALL.

Press RECALL.

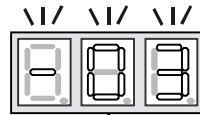

Press RECALL.

Press TEST to complete setting and return to setting mode.

Press RECALL.

SETTINGS MODE 2

< SCREEN 4 >

Setting Mode 2 allows the user to change system settings. See table in back of this section.

< SCREEN 0 >

OFF

ON



Blink interval:
0.4 sec. On - 0.4 sec. Off

< SCREEN 2 >

Hold **RECALL** and **TEST**.

Press **LEARN**.

< SCREEN 4 >

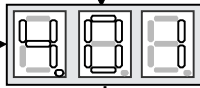

Press **RECALL**
to increase the number.

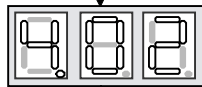

Press **RECALL**.

Press **RECALL**.

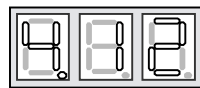

Press **TEST**
to change setting.

Press **RECALL**.

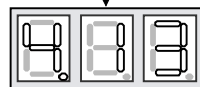

Press **TEST** to complete setting and return to setting mode.

Press
RECALL

< Changing setting display >

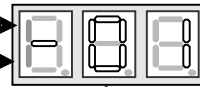

Press **RECALL**.

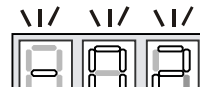

Press **TEST**.

Press
RECALL.

Press **RECALL**.

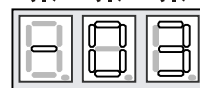

Press **RECALL**.

SERVICING

7-SEGMENT DISPLAY

SCREEN 0 (Display FAULT CODE)

Setting No.	Contents	Notes
1	Fault code (present)	

SCREEN 1 (Display FAULT CODES)

Setting No.	Contents	Notes
1	Fault code (latest)	Latest
2	Fault code (2nd)	2nd
3	Fault code (3rd)	3rd
4	Fault code (4th)	4th
5	Fault code (5th)	5th
6	Fault code (6th)	6th

SCREEN 2 (MONITOR MODE)

Setting No.	Contents	Notes
1	Compressor operation time	unit : hr (Multiply by 200,)
2	Operation code	0: Stop 1: Cooling Start-up 2: Heating Start-up 3: Oil Return Operation 4: Heating Operation 5: Defrost Operation 6: Cooling Operation
3	Compressor Reduction Mode	0:OFF,1:ON
4	% demand	unit : % (Cut off the decimal first place.)
5	act % demand	unit : % (Cut off the decimal first place.)
6	Requested ID CFM	unit : CFM (Multiply by 10)
7	Reported ID CFM	unit : CFM (Multiply by 10)
8	Outdoor FAN RPM	unit : RPM (Multiply by 10)
9	Ta (Outdoor Air Temperature)	unit : F
10	Td (Discharge Temperature)	unit : F
11	Tm (Outdoor Coil Temperature)	unit : F
12	Tb (Defrost Sensor Temperature)	unit : F
13	TI (Liquid Temperature)	unit : F
14	Pressure Sensor	unit : PSI

SERVICING

7-SEGMENT DISPLAY

SCREEN 3 (SETTING MODE 1)

Setting No.	Contents	Setting	Installer/Service Notes
1	Cool Airflow Trim High ^{*1, *2}	0: -15% 2: -5% 4: 5% 6: 15% 1: -10% <u>3: 0%</u> 5: 10%	
2	Cool Airflow Trim Int	0: -15% <u>3: 0%</u> 6: 15% 9: Full (Max) ^{*3} 1: -10% 4: 5% 7: 20% 2: -5% 5: 10% 8: 30%	
3	Cool Airflow Trim Low	0: -15% <u>3: 0%</u> 6: 15% 9: Full (Max) ^{*3} 1: -10% 4: 5% 7: 20% 2: -5% 5: 10% 8: 30%	
4	Cool Profile	0: A 1: B 2: C <u>3: D</u>	
5	Cool Fan ON Delay	<u>0: 5sec.</u> 1: 10sec. 2: 20sec. 3: 30sec.	
6	Cool Fan OFF Delay	<u>0: 30sec.</u> 1: 60sec. 2: 90sec. 3: 120sec.	
7	Dehumidification Select ^{*4}	<u>0: STD</u> 2: A 4: C 1: OFF 3: B	
8	Heat Airflow Trim High ^{*1}	0: -15% 2: -5% 4: 5% 6: 15% 1: -10% <u>3: 0%</u> 5: 10%	
9	Heat Airflow Trim Int	0: -15% 2: -5% 4: 5% 6: 15% 1: -10% <u>3: 0%</u> 5: 10%	
10	Heat Airflow Trim Low	0: -15% 2: -5% 4: 5% 6: 15% 1: -10% <u>3: 0%</u> 5: 10%	
11	Heat Fan ON Delay	<u>0: 5sec.</u> 1: 10sec. 2: 15sec.	
12	Heat Fan OFF Delay	<u>0: 30sec.</u> 1: 50sec. 2: 70sec. 3: 90sec.	
13	Airflow Trim Offset ^{*1, *2}	<u>0: 0%</u> 1: +2.5%	Used for additional trim setting by adding 2.5% to basic airflow trim setting. This setting affects all trim settings except +15% High (cooling or heating).

NOTE: Parameters as per factory setting are highlighted in bold and underlined.

*1 *VZC200601* with **VC960804C, **VM970804C and *MVC800804C combination trim more than 5% settings are invalid.
Trimmed up CFM makes miss matching error.

*2 Depending on the connected indoor unit, there are restrictions on the positive side Trim setting.
If you want to change the Cool Airflow Trim to positive side, be sure to confirm the Airflow Trim restrictions in the latest indoor unit installation manual. The latest manual can be obtained from the website "PartnerLink(InfoFinderPlus/Literature)".
[PartnerLink URL]

<https://partnerlinkmarketing.goodmanmfg.com/goodman/info-finder-plus>

*3 The Inverter system uses lower compressor speed and lower indoor unit CFM to optimize system performance.
To obtain 100% CFM for home circulation, use full Trim setting instead of Int/Low speed.
This is recommended for applications with unusually cold return temperatures such as basements.

*4 Please refer to the page of "DEHUMIDIFICATION SELECT" for details of this function.

NOTE:
The specification of *VZC200241AF, 0361AE, 0481AE and 0601AE or earlier models are different from this specification. For details, see the Installation Manual or Service Manual that matches the Major and Minor revision of

SERVICING

7-SEGMENT DISPLAY

SCREEN 4 (SETTING MODE 2)

Setting No.	Contents	Setting	Installer / Serviceman Notes
1	Maximum Defrost Interval	<u>0: 30min.</u> 1: 60min. 2: 90min. 3: 120min.	
2	Set Maximum Current	N/A	Future Use
3	Vertical Rise	0:Same Level <u>1:Outdoor Lower</u> 2:Indoor Lower	
4	System Verification Test (System Test)	0:ON <u>1:OFF</u>	
7	Force Defrost Cycle	0:ON <u>1:OFF</u>	
8	Pump Down	0:ON <u>1:OFF</u>	
9	Charge Mode	0:ON <u>1:OFF</u>	
10	Maximum Compressor RPS for Cooling	*	
11	Maximum Compressor RPS for Heating	*	
12	BOOST Mode Selection	<u>0:ON</u> 1:OFF	
13	BOOST Mode Temperature	<u>0:105F</u> , 1:100F, 2:95F, 3:90F, 4:85F, 5:80F, 6:75F, 7:70F, 8:Always ON	

**Depends on tonnage. Can adjust compressor RPS in each 0.5 RPS*

NOTES:

- Parameters as per factory setting are highlighted in bold and underlined.
- BOOST MODE is applicable only for *VXC20**1 or later revision.

SERVICING

CTK04** COMFORTNET™ THERMOSTAT OVERVIEW

The ComfortNet™ system (or CT system) is a system that includes a ComfortNet compatible modular blower heat pump condenser with a CTK04** thermostat. The table below compares the valid CT systems.

<i>CT compatible Air Handler or Modular Blower</i>	<i>CT compatible Heat Pump Unit</i>	<i>Full CT system benefits & features</i>
--	-------------------------------------	---

A ComfortNet heating/air conditioning system differs from a legacy/traditional system in the manner in which the indoor unit, outdoor unit and thermostat interact with one another. In a traditional system, the thermostat sends commands to the indoor and outdoor units via analog 24 VAC signals. It is a one-way communication path in that the indoor and outdoor units typically do not return information to the thermostat.

On the other hand, the indoor unit, outdoor unit, and thermostat comprising a ComfortNet system “communicate” digitally with one another. It is now a two-way communications path. The thermostat still sends commands to the indoor and outdoor units. However, the thermostat may also request and receive information from both the indoor and outdoor units. This information may be displayed on the CT thermostat. The indoor and outdoor units also interact with one another. The outdoor unit may send commands to or request information from the indoor unit. This two-way digital communications between the thermostat and subsystems (indoor/outdoor unit) and between subsystems is the key to unlocking the benefits and features of the ComfortNet system.

Two-way digital communications is accomplished using only two wires. The thermostat and subsystem controls are powered with 24 VAC. Thus, a maximum of 4 wires between the equipment and thermostat is all that is required to operate the system.

CTK04 WIRING

NOTE: A removable plug connector is provided with the control to make thermostat wire connections. This plug may be removed, wire connections made to the plug, and replaced. It is strongly recommended that you do not connect more than two wires into a single terminal in the field because there is a risk of the wires becoming loose. Failure to do so may result in intermittent operation.

Typical 18 AWG thermostat wire may be used to wire the system components. However, communications reliability may be improved by using a high quality, shielded, twisted pair cable for the data transmission lines. In either case, 250 feet is the maximum length of wire between indoor unit and outdoor unit, or between indoor unit and thermostat. Please use a thermostat model later than CTK04AE.

CTK04 ADDENDUM

TWO-WIRE OUTDOOR, FOUR-WIRE INDOOR WIRING

Low voltage wiring consists of two wires between the indoor unit and outdoor unit and four wires between the indoor unit and the thermostat. The required wires are: (a) data lines, 1 and 2; (b) thermostat “R” (24 VAC hot) and “C” (24 VAC common).

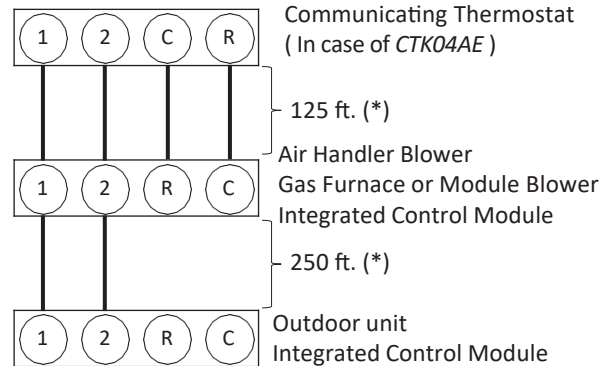

(*) Allowable Maximum Length

SYSTEM WIRING SYSTEM WIRING USING FOUR-WIRES

Two wires only may be utilized between the indoor and outdoor units. For this wiring scheme, only the data lines, 1 and 2, are required between the indoor and outdoor units.

SERVICING

THERMOSTAT MENU SCREEN
SYSTEM START-UP TEST

NOTICE

ON INITIAL POWER START-UP, THE OUTDOOR UNIT WILL DISPLAY CODE E11, SIGNALING THAT INITIAL SYSTEM TEST MUST BE RUN. FOLLOW THE COMFORTNET™ SETUP SCREEN TO ENTER APPLICATION-UNIQUE INFORMATION. SEE COMFORTNET THERMOSTAT MANUAL FOR DETAILED INFORMATION.

A system test is now required to check the equipment settings and functionality. Once selected, it checks the equipment for approximately 5 - 15 minutes. System test may exceed 15 minutes if there is an error. Refer to the Troubleshooting section, if error code appears. Before starting the SYSTEM TEST, turn off the electric heater and gas furnace.

NOTE: If the unit is attempting to run SYSTEM TEST in under 20° F ambient temperature, the unit may not be able to complete the test due to low suction pressure. In such a case, re-run the SYSTEM TEST when the ambient temperature exceeds 20° F.

1. Ensure the thermostat is installed.
2. Apply power to outdoor and indoor units.
3. Start-up.
After the application information is entered, the initial system test must be run.

NOTICE

FOR INVERTER HEAT PUMP CONDENSER SYSTEM USING COMFORTNET, DO NOT INSTALL A TRANSFORMER.

The HOME screen will be displayed showing information similar to one of the adjacent screens. Select MENU. Make sure the thermostat is in OFF mode and select SYSTEM MENU. Choose OFF before SYSTEM VERIFICATION test.

NOTE: Either screen may be displayed. SYSTEM TEST must be run for all installations. System will not operate without a completed initial SYSTEM TEST.

NOTE: The thermostat screen may indicate to run a SYSTEM VERIFICATION test.

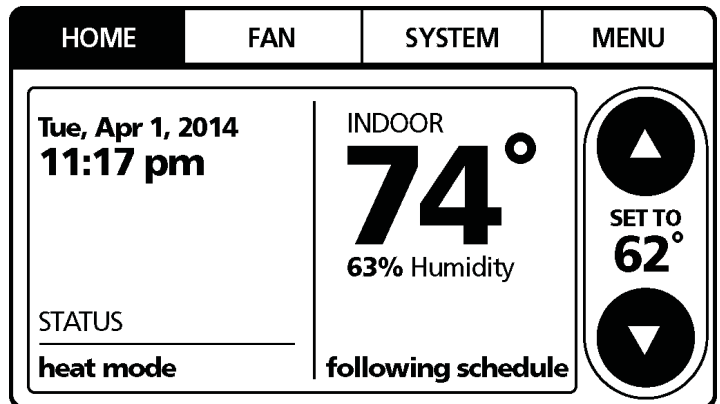
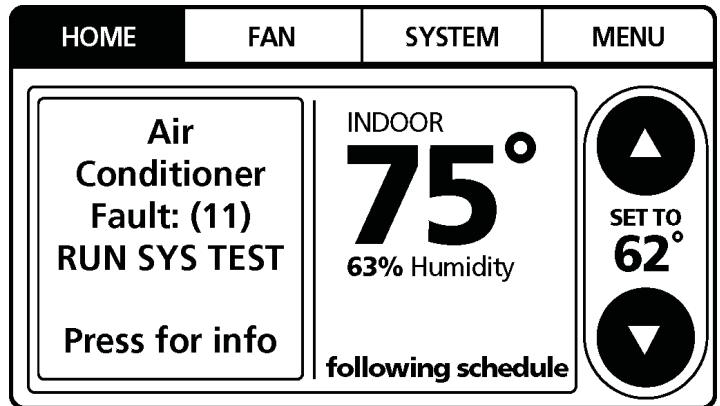

- From the MENU screen, scroll down and select ComfortNet™ USER MENU.

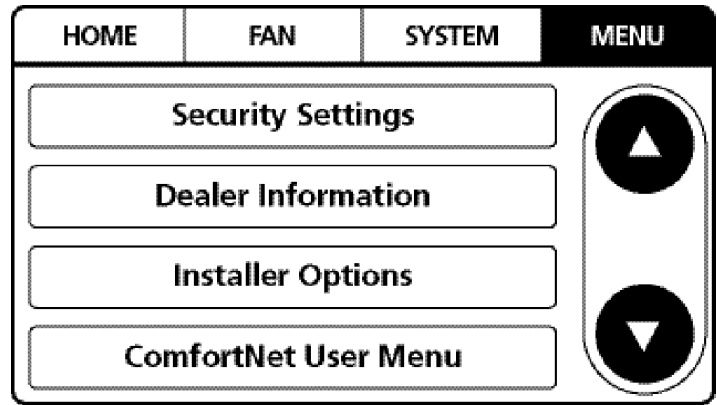

- Enter Installer password. (The password is the Date Code located on the thermostat and is available by entering the EQUIPMENT STATUS menu and scrolling to the bottom.)

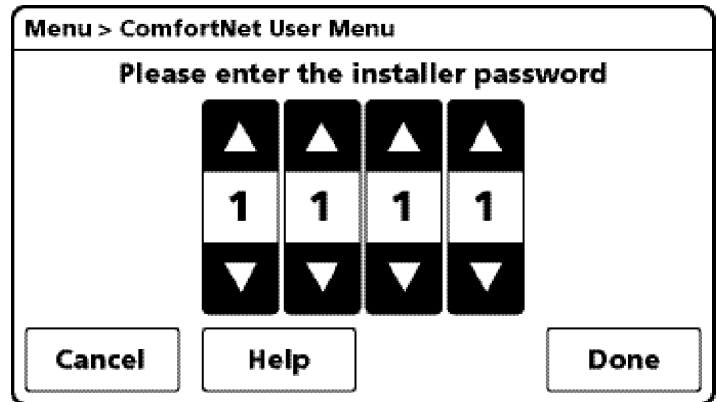

- Select YES to continue.

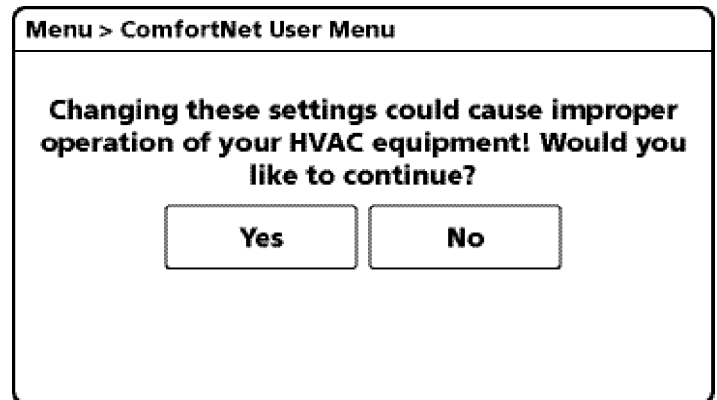

- From the ComfortNet USER MENU, select HEAT PUMP. Note: Screen may show air handler or furnace depending on the type of system installed.

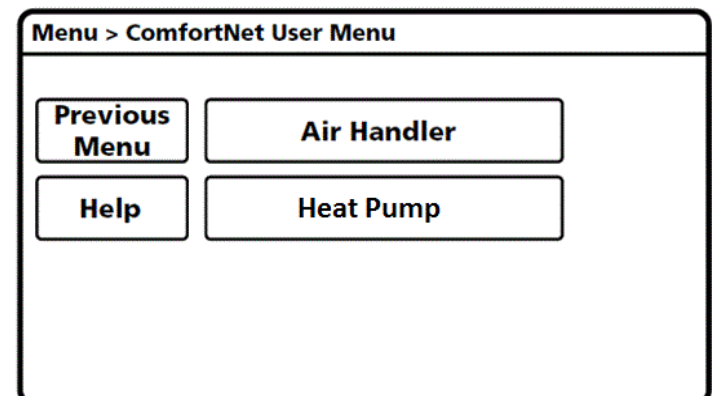

SERVICING

8. Next, scroll down and select EQUIP TEST.

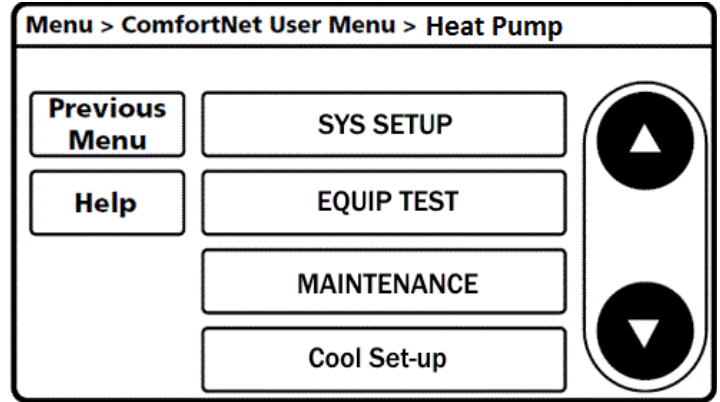

9. Select SYSTEM TEST.

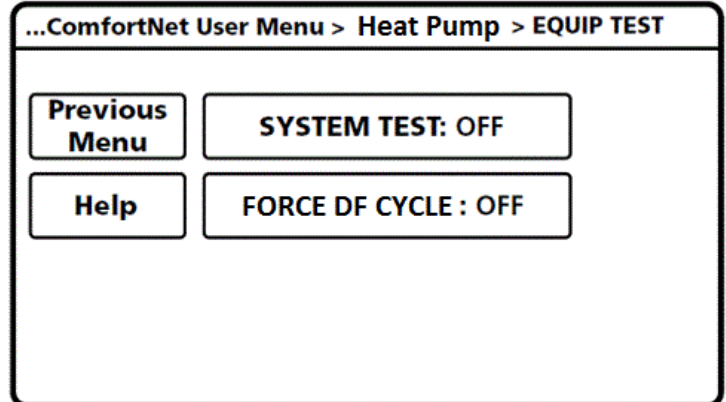

10. Select ON to run the SYSTEM TEST.
Press DONE to initiate test.

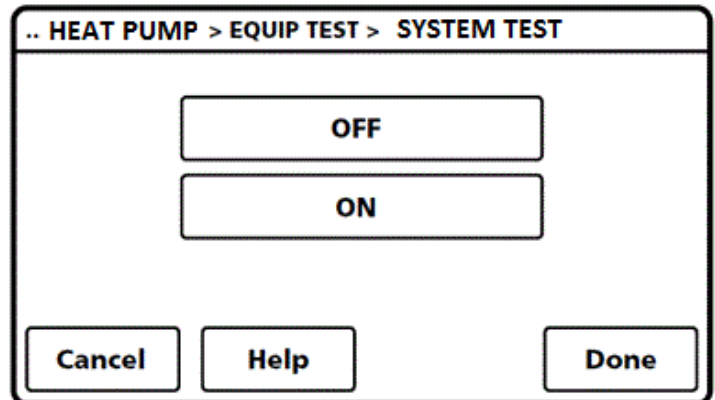

11. Allow the system test to run for its duration (5-15 minutes). EQUIP TEST SCREEN will show the system test is ON once selected. System test will operate the outdoor unit and the indoor unit through a series of startup tests. Please proceed to the next step and allow for startup tests to complete. Do not interrupt power to outdoor unit, indoor unit, or thermostat during system test.

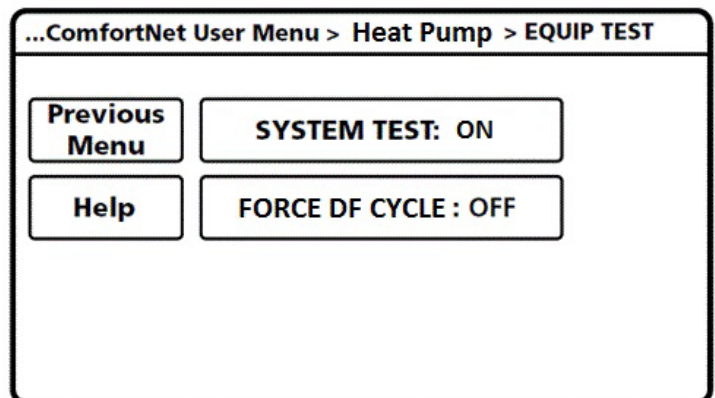

SERVICING

12. Press Previous Menu button and navigate to HOME screen and allow test to finish. The display similar to the one at the right will be displayed after SYSTEM TEST completes. Test is complete only when CODE 11 notice clears from BOTH the thermostat display AND the seven segment LED display on the outdoor unit. Please wait for test to complete and for both codes to clear.

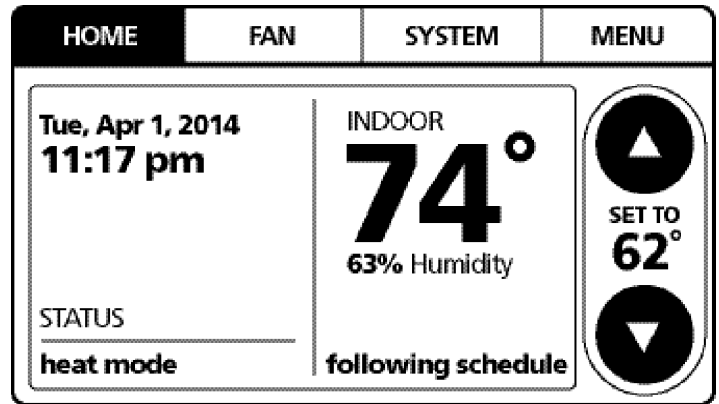

SET THERMOSTAT TO CHARGE MODE

Please follow the following sequence to enter CHARGE Mode.

CHARGE mode allows for charging of the system. System operates for a duration of approximately one hour while the equipment runs at full capacity. After one hour, the charge mode ends and the system resumes normal thermostat operation.

Before starting the charge mode, turn off the electric heater and gas furnace.

1. On the HOME screen, select MENU.
NOTE: Ensure the thermostat is in the OFF mode.
Select SYSTEM menu. Choose OFF before CHARGE MODE.

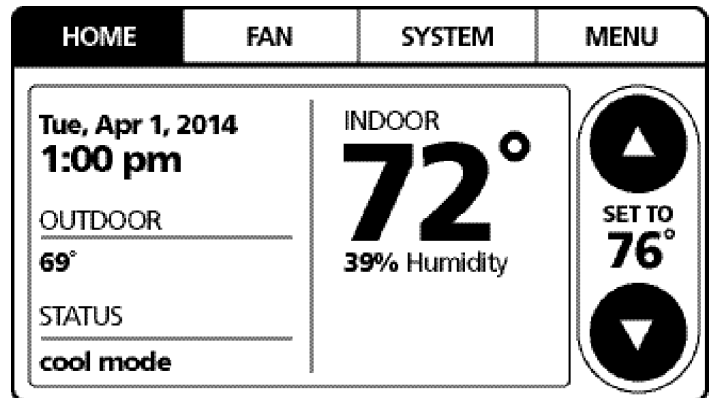

2. From the MENU screen, scroll down and select COMFORTNET™ USER MENU.

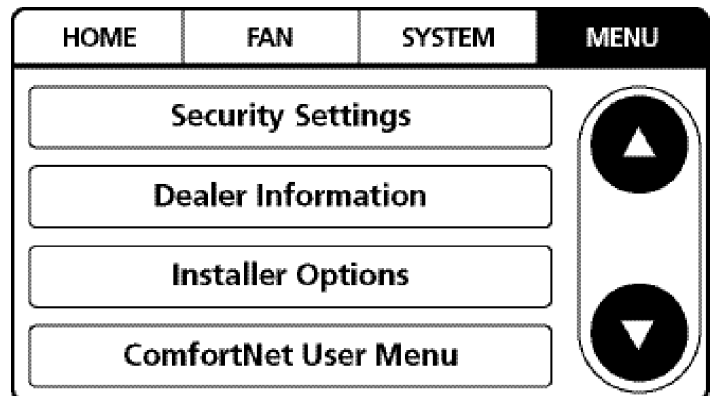

SERVICING

3. Enter Installer password. (The password is the Date Code located on the thermostat and is available by entering the EQUIPMENT STATUS menu and scrolling to the bottom).

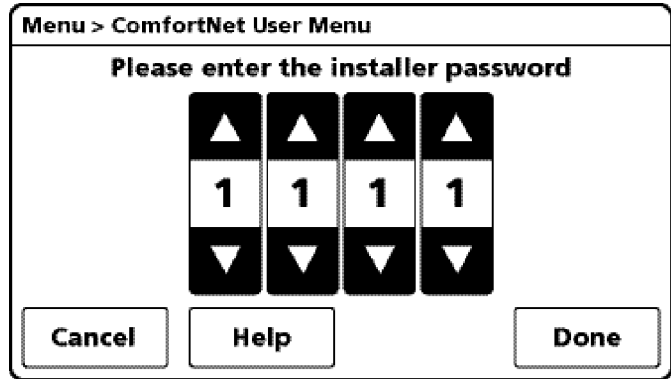

4. Select YES to continue.

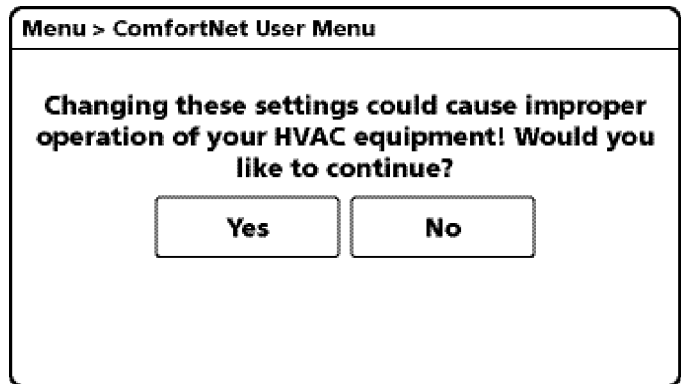

5. Select HEAT PUMP.

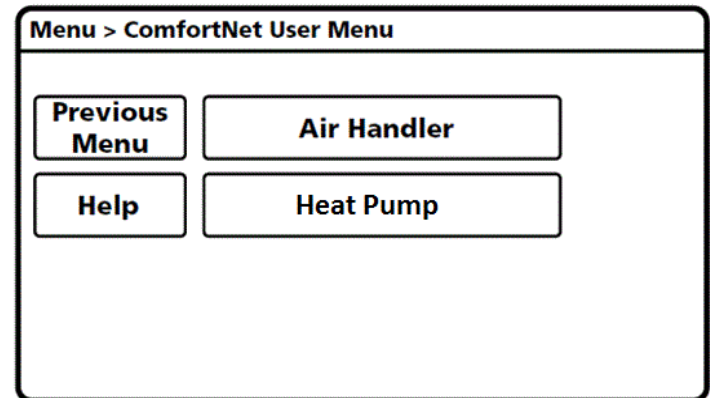

6. Select MAINTENANCE.

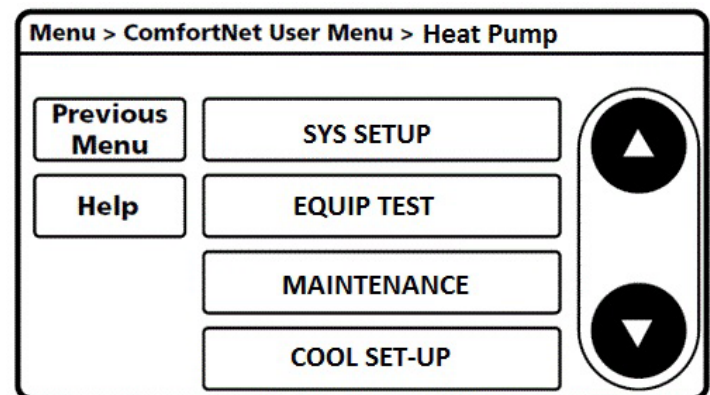

SERVICING

7. Select CHARGE Mode.

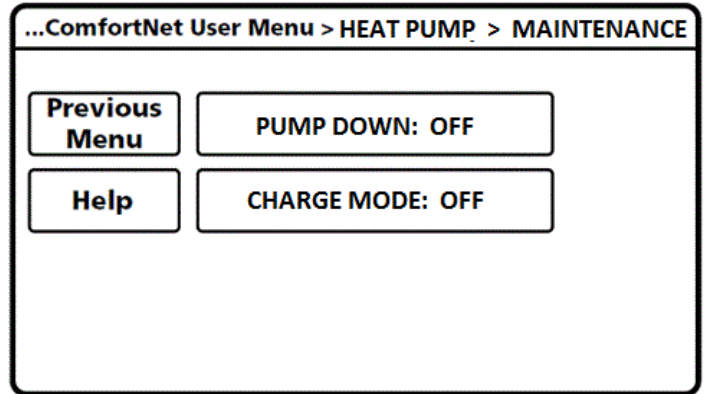

8. Select ON. Press DONE to initiate CHARGE Mode. (System will then run for 1 hour and either return to cooling or heating mode depending on if the mode thermostat is set at COOL or HEAT MODE from the SYSTEM menu on the main screen. If charging is not complete after 1 hour, repeat 7. and 8. Refer to S-103 for refrigerant charge level adjustment.

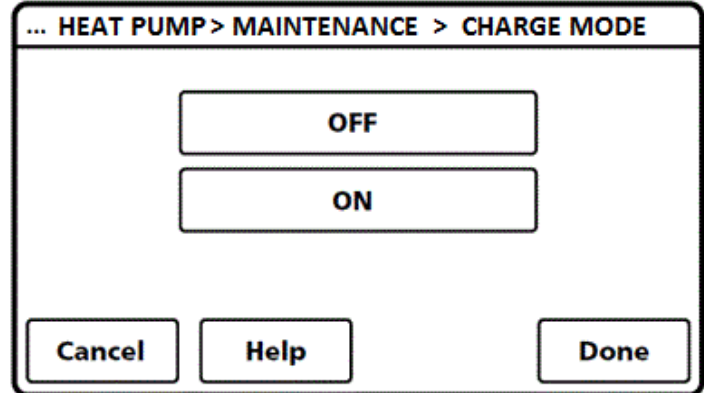

9. To terminate CHARGE MODE, select CHARGE Mode screen again. Press OFF. Press DONE to terminate CHARGE MODE.

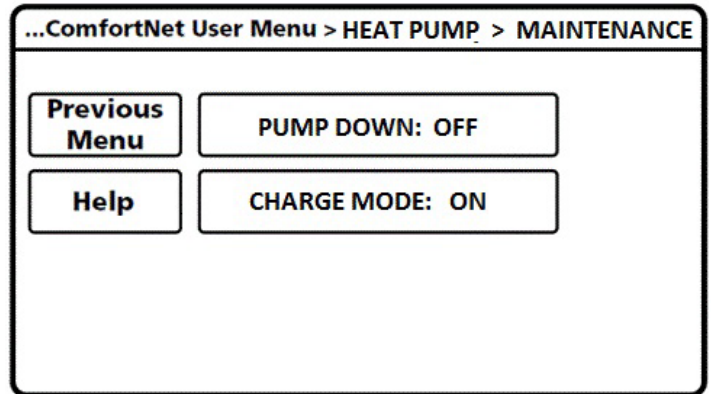

10. Once CHARGE MODE is complete and has been terminated, navigate to HOME screen. Enter normal operation with temperature offset or thermostat schedule, as desired.

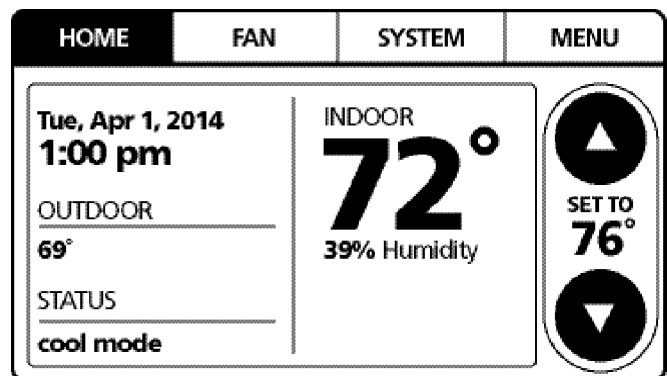

SERVICING

BOOST MODE

BOOST MODE enables the system to operate at a higher compressor speed than rated maximum compressor speed and satisfy the structural load more effectively during higher ambient outdoor conditions. BOOST MODE is initiated by an outdoor temperature sensor located in the outdoor unit. Please note that outdoor equipment operational sound levels may increase while the equipment is running in BOOST MODE. Disabling BOOST MODE will provide the quietest and most efficient operation.

NOTE: BOOST MODE is applicable only for *VZC20** or later revision. BOOST MODE performance is most effective when paired with an electronic expansion valve enabled indoor unit.

BOOST MODE is ON by default and is activated when the outdoor temperature reaches 105°F. BOOST MODE can be disabled and enabled and the activation temperature adjusted in the BOOST TEMP menu using the following procedure:

1. On the CTK04 HOME screen, select MENU.

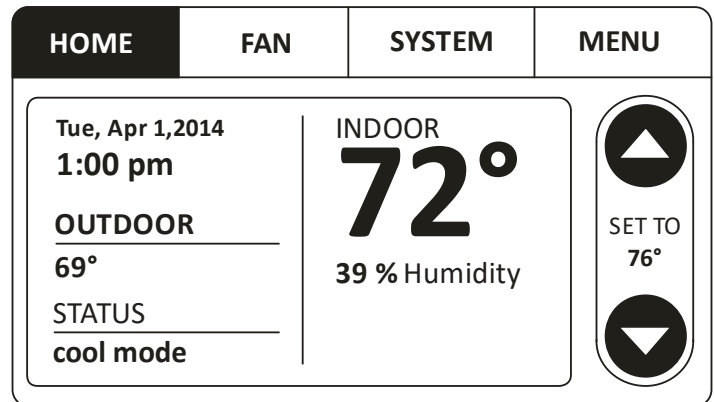

2. From the MENU screen, select COMFORTNET™ USER MENU.

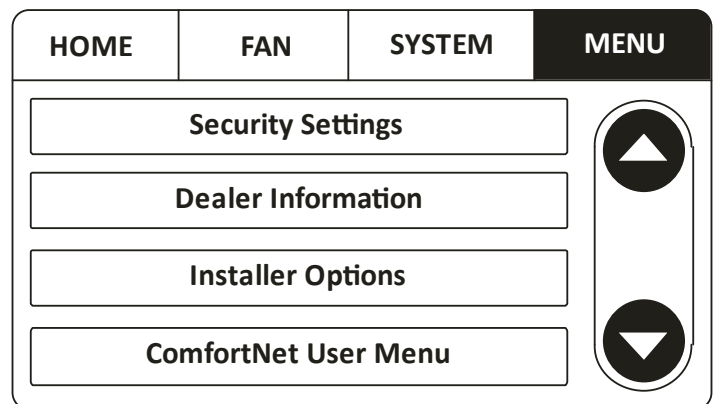

SERVICING

- 3. Enter Installer password, if known.
 - a. The password is the thermostat date code and can be obtained by selecting the red Cancel button and selecting the Dealer Information button.
 - b. Once recorded, click the green OK button and return to previous step.

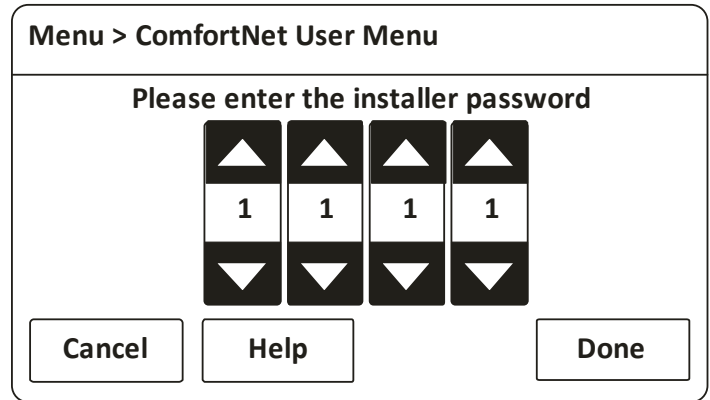

- 4. Select YES to continue.

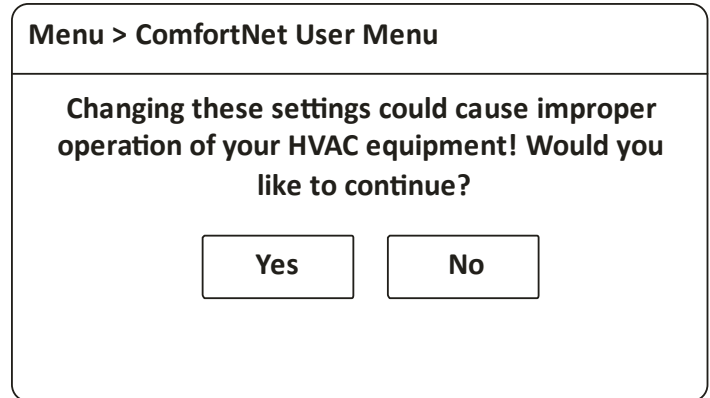

- 5. Select HEAT PUMP.

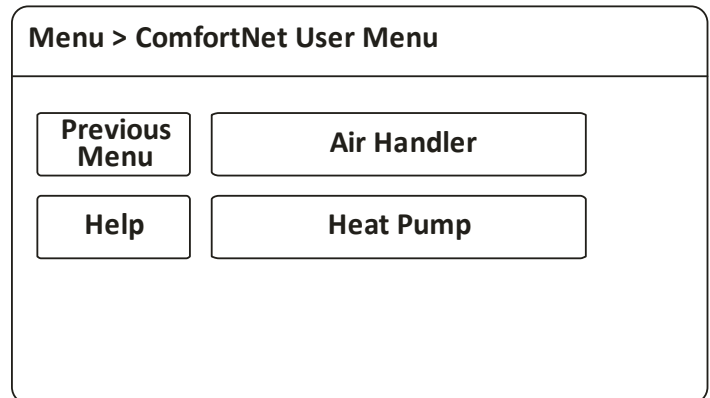

- 6. Select SYS SETUP.

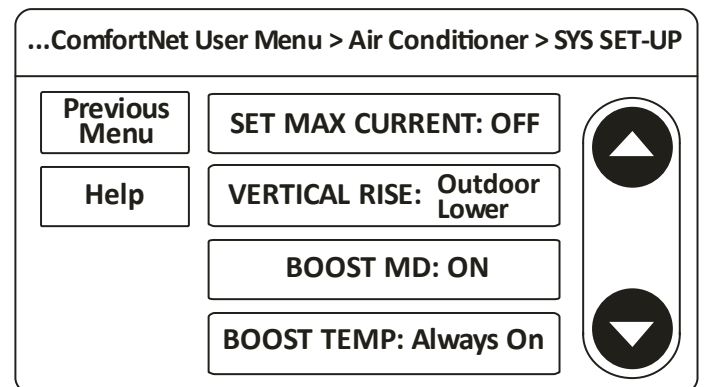

SERVICING

7. BOOST MD turns BOOST MODE OFF or ON. BOOST MODE is ON by default.

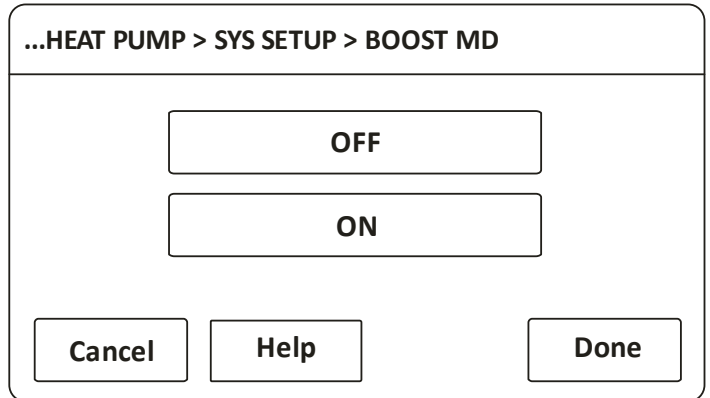
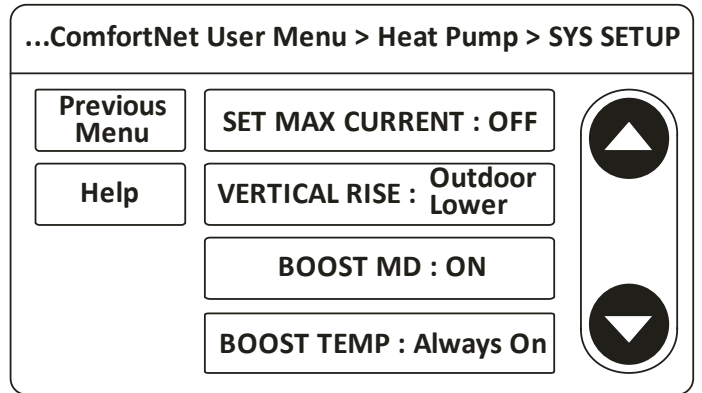

8. BOOST TEMP adjusts the activation temperature from 70°F to 105°F. "Always ON" option is also available to permanently engage BOOST MODE. Factory default is 105°F.

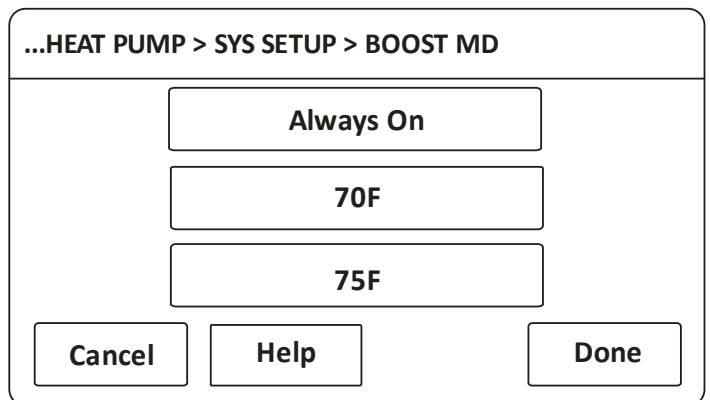
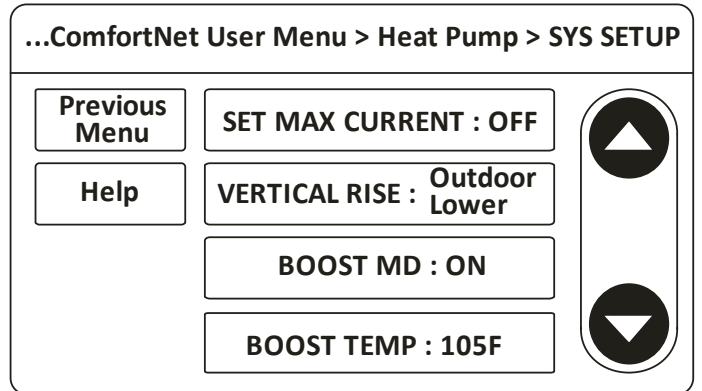

SERVICING

9. Once satisfied with BOOST MODE adjustments, navigate to the HOME screen by selecting the Previous Menu button three times then selecting HOME.

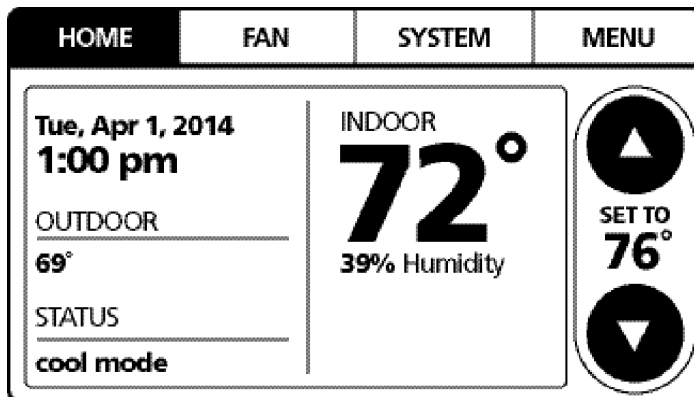

DEHUMIDIFICATION

The thermostat reads the indoor humidity level and allows the user to set a dehumidification target based on these settings. The thermostat controls the humidity level of the conditioned space using the cooling system. Dehumidification is engaged whenever a cooling demand is present and structural humidity levels are above the target level. When this condition exists, the circulating fan output is reduced, increasing system run time, over cooling the evaporator coil and ultimately removing more humidity from the structure than if only in cooling mode. The CTK04 also allows for an additional overcooling limit setting from 0°F to 3°F setup through the Installer Option menu (directions following). This allows the cooling system to further reduce humidity by lowering the temperature up to 3°F below the cooling set-point in an attempt to better achieve desired humidity levels. By default, dehumidification needs to be turned ON at the thermostat via the Dehumidification Equipment menu. Dehumidification can be activated at the original equipment setup by selecting the A/C with Low Speed Fan button in the Dehumidification Menu. Availability can be verified by pressing MENU on the home screen. Scroll down and if a Dehumidification button is present, dehumidification is activated.

If Dehumidification is not available in the menu then it must be enabled through the Installer Options menu. Use the following procedure to enable and disable dehumidification:

1. On the CTK04 HOME screen select MENU.
2. From the MENU screen, scroll down and select Installer Options.
3. Enter installer password if known.
 - a. The password is the thermostat date code and can be obtained by selecting the red Cancel button and selecting the Dealer Information button.
 - b. Once recorded, click the green OK button and return to the previous step.
4. Select YES to continue.
5. Select View / Edit Current Setup.

6. Scroll down and select Dehumidification.
7. Once open select Dehumidification Equipment: None.
8. From the Dehumidification Menu select A/C with Low Speed Fan and click the green Done button.
9. Additional Dehumidification operational options can be selected in the resulting window.
10. Once satisfied with the selection, navigate to the HOME screen by selecting the Done button and selecting Yes to verify the changes.
11. Select Previous Menu, then the HOME to return to the main menu.

DEHUMIDIFICATION TIPS*

For effective dehumidification operation:

- Ensure “Dehum” is NOT set to “OFF” through the Installer Options menu and/or in the ComfortNet User Menu (COOL SETUP).
 - If except OFF, the Dehumidification menu should be visible in the main menu.
 - Verify the cooling airflow profile is set to “Profile D”.
 - See the Cool Set-up section of the Installation Manual for complete airflow profile details.
 - By default, “Dehum” is STD and the cooling airflow profile is set to “Profile D”.
 - For additional dehumidification control, airflow settings are field adjustable and can be fine-tuned to a value that is comfortable for the application from a range of Cool Airflow Trim.
 - In addition, the system can have Enhanced Dehumidification operation in setting “A”, “B”, or “C” of “Dehum” based on dehumidification demand..
 - See the DEHUMIDIFICATION SELECT section for more detail.
- * The specification of *VZC200241AF, 0361AE, 0481AE, and 0601AE or earlier models are different from this specification. For details, see the Installation Manual or Service Manual that matches the Major and Minor revision of model name.

SERVICING

DEHUMIDIFICATION SELECT*

When Dehumidification mode exists, the circulating fan output is reduced, increasing system run time, over cooling the evaporator coil and ultimately removing more humidity from the structure than if only in cooling mode. The system can have Dehumidification operation in setting “STD”, “A”, “B” or “C” of “Dehumidification Select” based on dehumidification demand. Setting “STD” allows for the widest compressor operation range with lower CFM than Cooling mode. In the Enhanced Dehumidification (setting A, B and C) the indoor airflow is lower than Standard Dehumidification (STD). Setting “A” allows for the same compressor operation range in Dehumidification operation with lower CFM than standard dehumidification (STD). Setting “B” limits compressor operation range and keeps high dehumidification capacity. In setting “C” the system runs fixed at 100% compressor and airflow. See Figure 1.

NOTE: In high humidity environments, sweating on supply ducts, cased coils or air handler cabinets can become an issue in Enhanced Dehumidification operation. It is strongly recommended covering them with 2” fiberglass insulation for these installations.

* The specification of *VZC200241AF, 0361AE, 0481AE and 0601AE or earlier models are different from this specification.

For details, see the Installation Manual or Service Manual that matches the Major and Minor revision of model name.

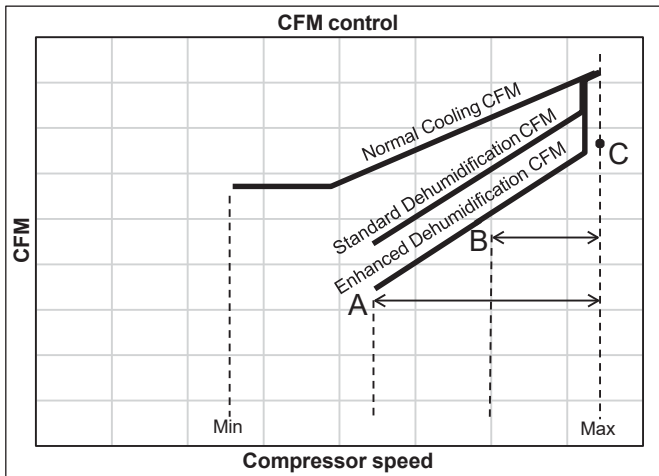

SERVICING

SET THERMOSTAT TO ADJUST MAXIMUM COMPRESSOR SPEED

Please follow the following sequence to enter MAXIMUM compressor speed.

Maximum compressor speed at which the outdoor unit will operate in cooling or heating mode can be changed using thermostat. Maximum compressor speed can be changed to get the required capacity or efficiency. Once the maximum speed is set, the system operates between the set maximum speed and default low speed.

1. On the HOME screen, select MENU

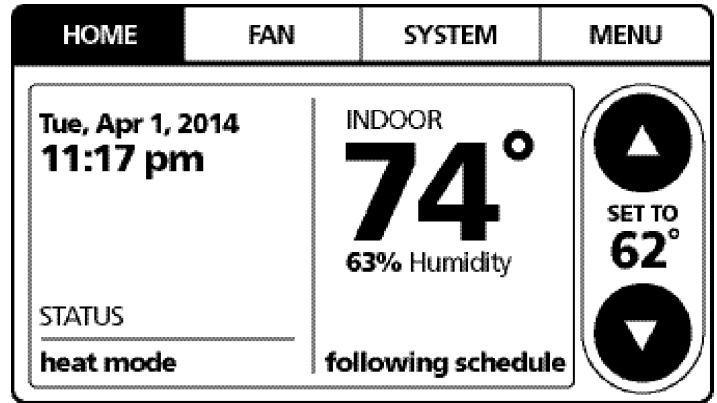

2. From the MENU screen, select COMFORTNET™ USER MENU.

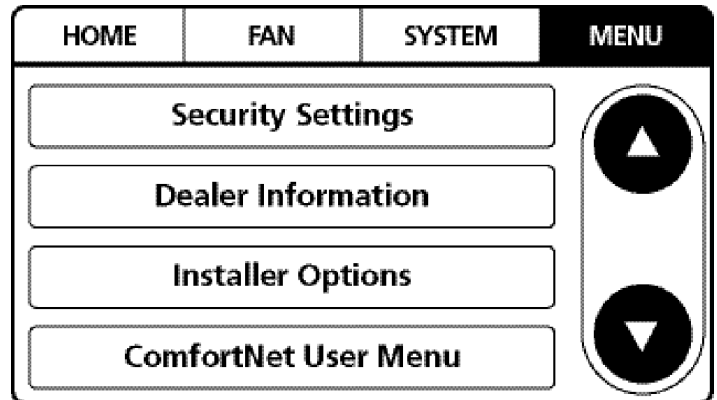

3. Enter Installer password. (The password is the Date Code located on the thermostat and is available by entering the EQUIPMENT STATUS menu and scrolling to the bottom).

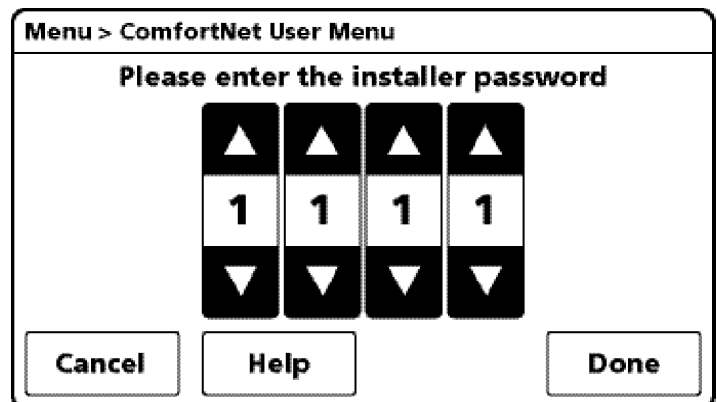

SERVICING

4. Select YES to continue.

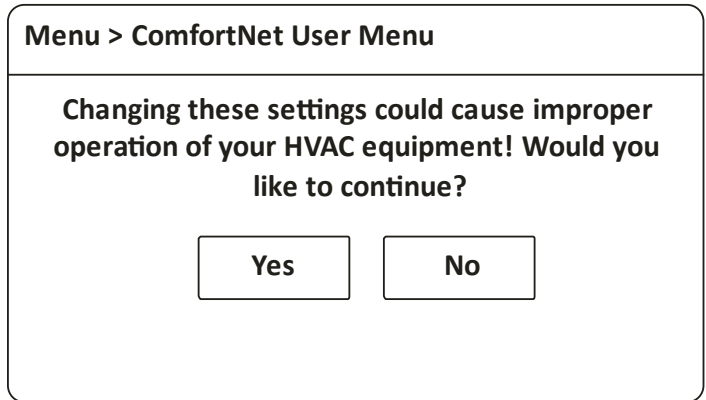

5. Select HEAT PUMP.

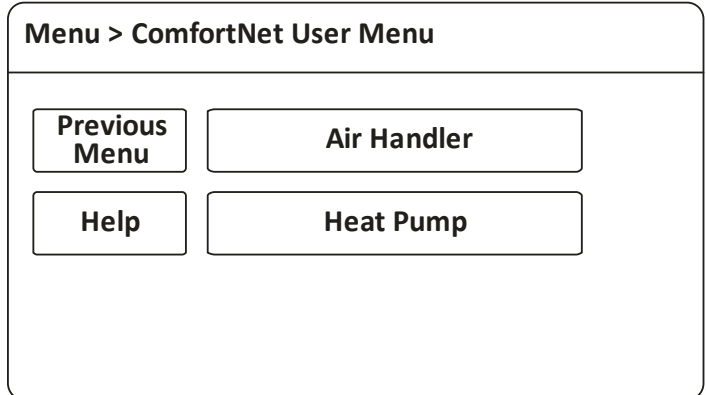

6. Select
CL RUN VALUES: for cooling mode
HT RUN VALUES: for heating mode

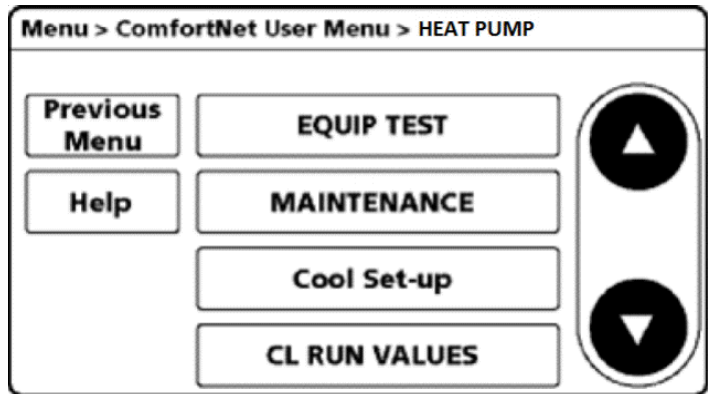

7. Select Cool/HEAT RPS RANGE.
Press Cool RPS Range (for cooling mode) or HEAT RPS RANGE (heating mode) to select the range in which the desired Maximum compressor speed falls.

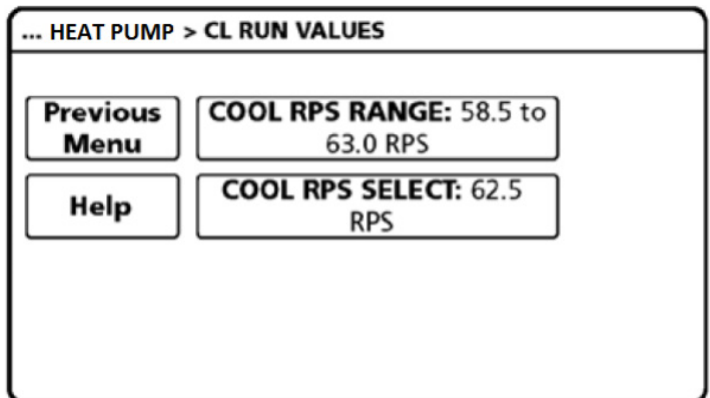

SERVICING

- Select Cool RPS SELECT (cooling mode) or HEAT RPS SELECT (heating mode).
Select the desired Maximum compressor speed

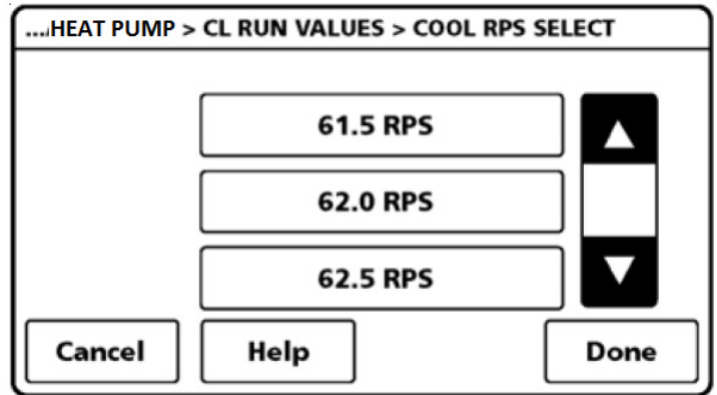

- Once Maximum compressor speed is set, navigate to HOME screen. Enter normal operation with temperature offset or thermostat schedule, as desired.

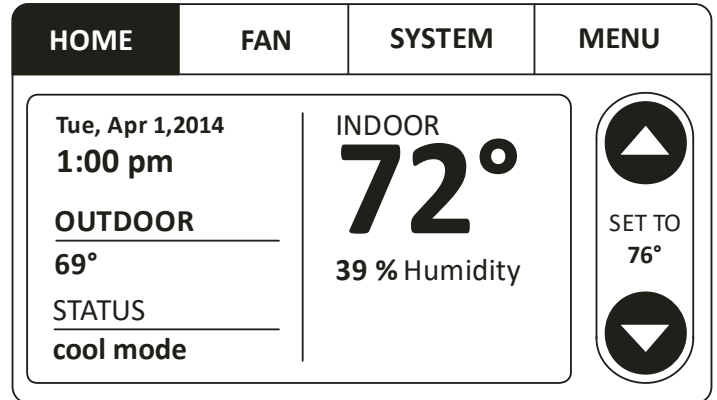

Set Thermostat to Adjust Indoor Air CFM trim

- On the HOME screen, select MENU

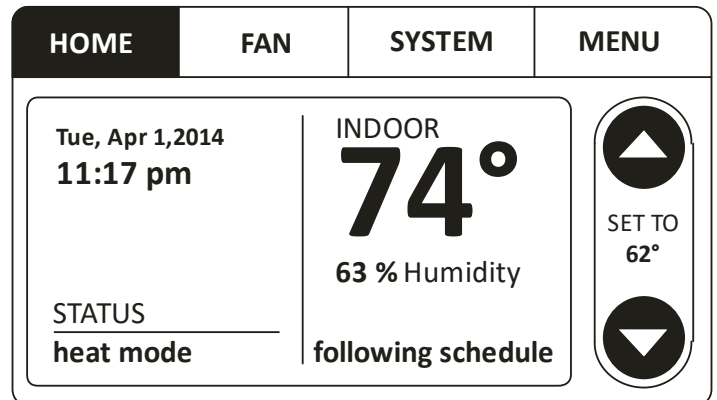

- From the MENU screen, select COMFORTNET™ USER MENU

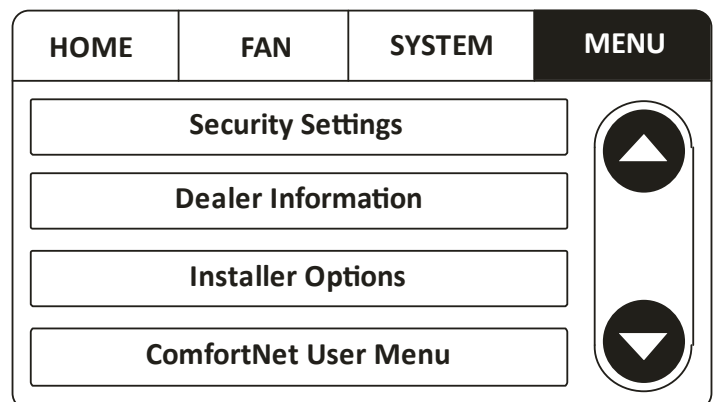

SERVICING

- 3. Enter Installer password. (The password is the Date Code located on the thermostat and is available by entering the EQUIPMENT STATUS menu and scrolling to the bottom).

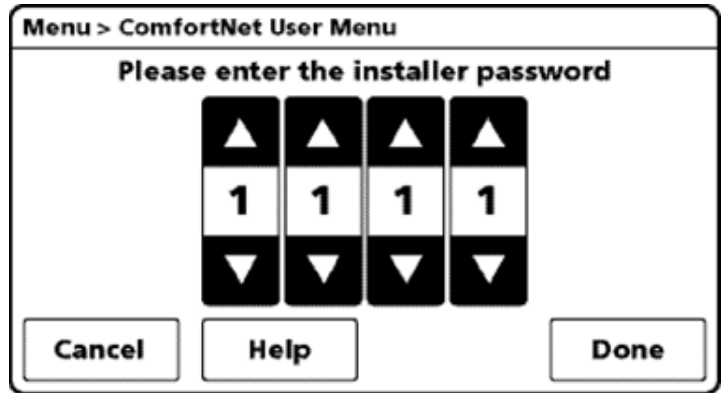

- 4. Select YES to continue.

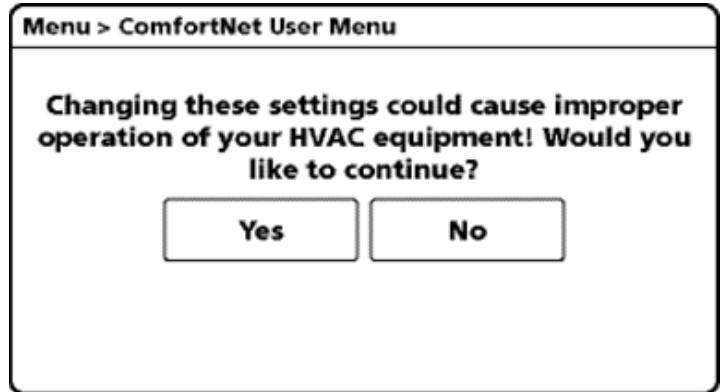

- 5. Select HEAT PUMP.

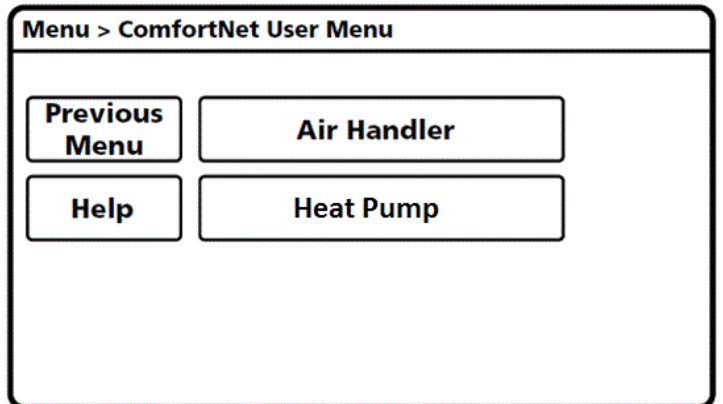

- 6. Select
Cool Setup: Cooling Mode
HEAT SETUP: Heating Mode

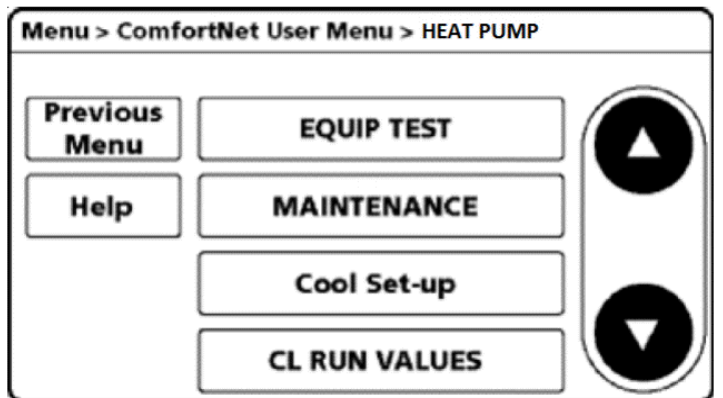

SERVICING

7. User can change the airflow trim at high, intermediate and low compressor for cooling and heating mode.

Select:

- Cool Airflow Trim Hi: high speed cooling
- Cool Airflow Trim Int: intermediate speed cooling
- Cool Airflow Trim Low: low speed cooling
- Heat Airflow Trim Hi: high speed heating
- Heat Airflow Trim Int: intermediate speed heating
- Heat Airflow Trim Low: low speed heating

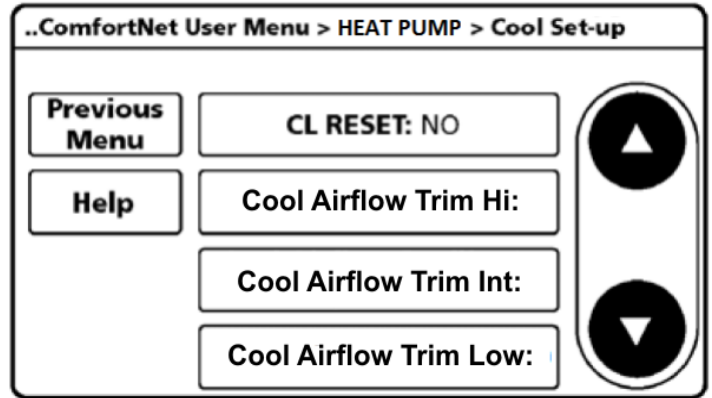

Under each trim setting, the airflow can be increased or decreased by a certain percentage. The increment that can be changed depends on the production date.

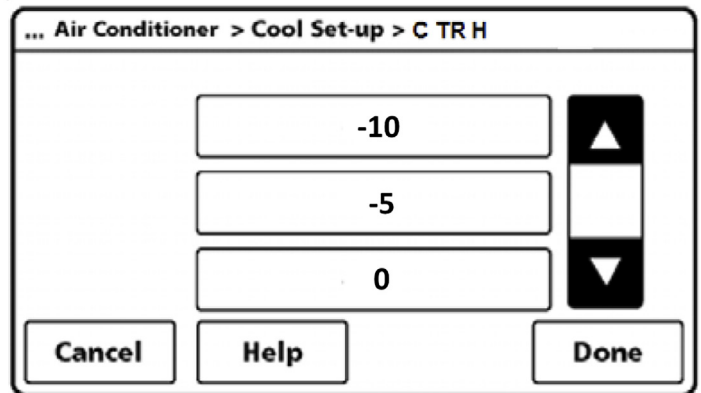

8. Once Cool Airflow Trim is set, navigate to HOME screen. Enter normal operation with temperature offset or thermostat schedule, as desired.

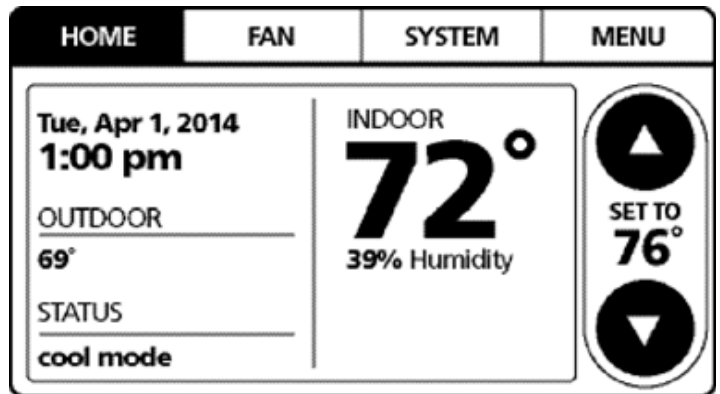

SERVICING

SET THERMOSTAT TO ADJUST INDOOR AIRFLOW PROFILE, COOL/HEAT ON DELAY AND COOL/HEAT OFF DELAY DEFROST

1. Please follow the sequence 1. to .6 of Set Thermostat To Adjust Indoor Air CFM trim

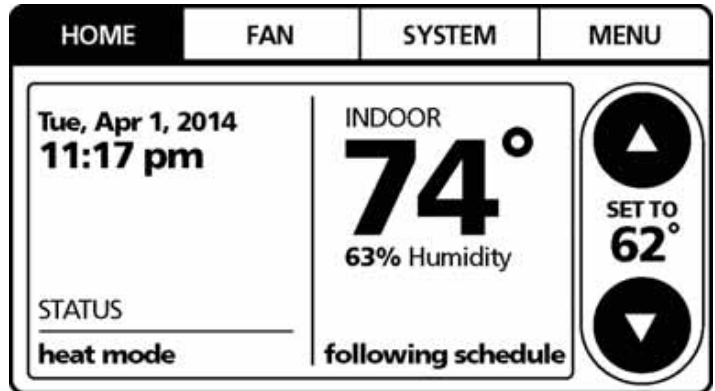

2. Select
Cool Set-up for Cool Airflow Profile, Cool ON Delay or Cool OFF Delay
Heat Set-up for Heat ON Delay or Heat OFF Delay
Heat Airflow Profile, DEFROST

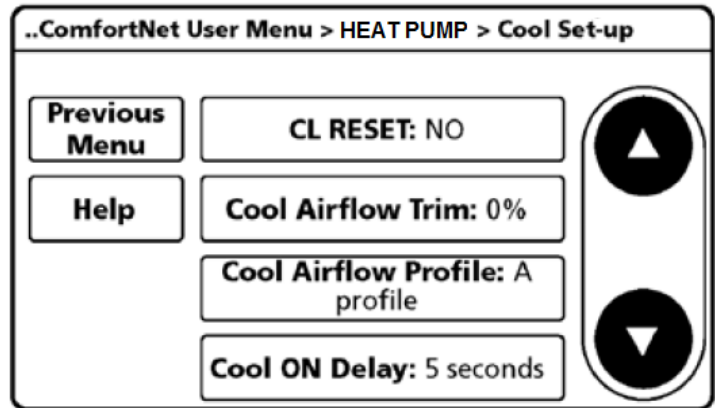

3. Once Cool Set-up / Heat Set-up settings are complete, navigate to HOME screen.

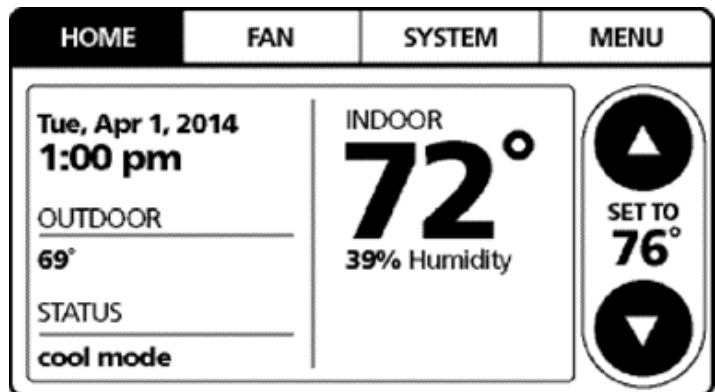

SERVICING

SET THERMOSTAT TO FORCE DEFROST CYCLE

Follow the following sequence to Force a defrost cycle.

NOTE: Unit will need to wait another 6 minutes before starting another force defrost cycle.

1. On the HOME screen, select MENU.

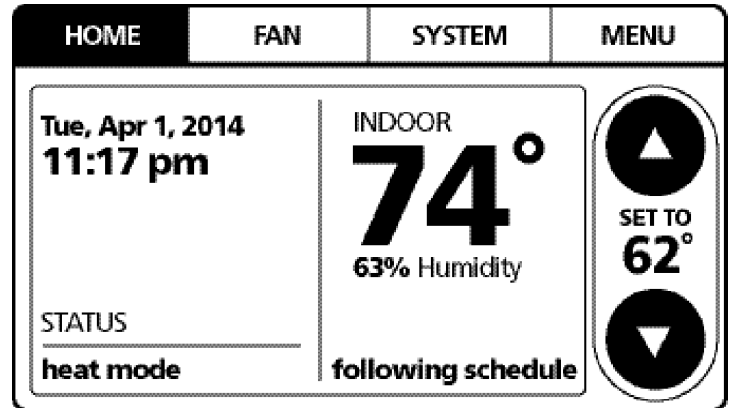

2. From the MENU screen, select COMFORTNET™ USER MENU.

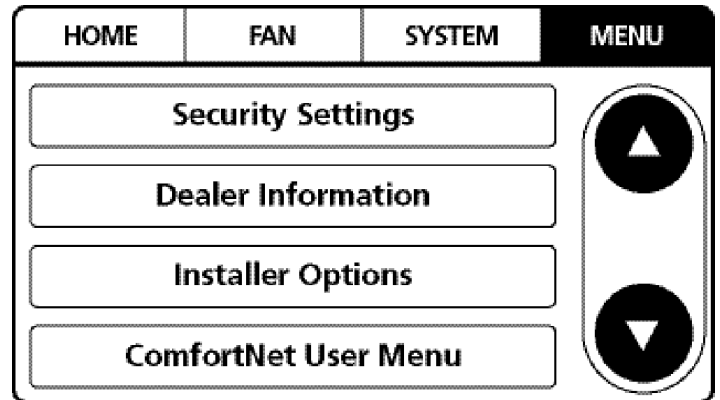

3. Enter Installer password. (The password is the Date Code located on the thermostat and is available by entering the EQUIPMENT STATUS menu and scrolling to the bottom).

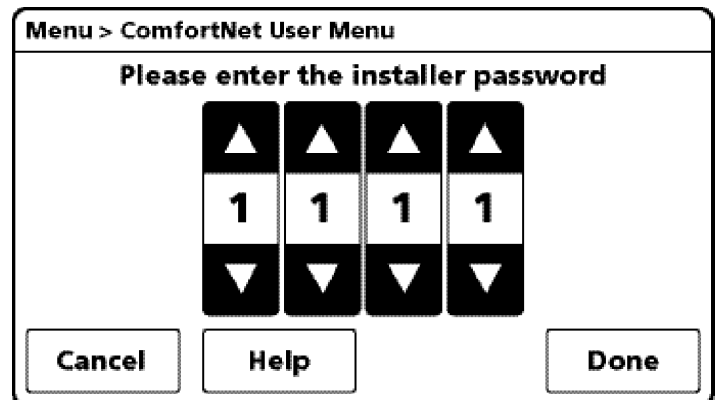

4. Select YES to continue.

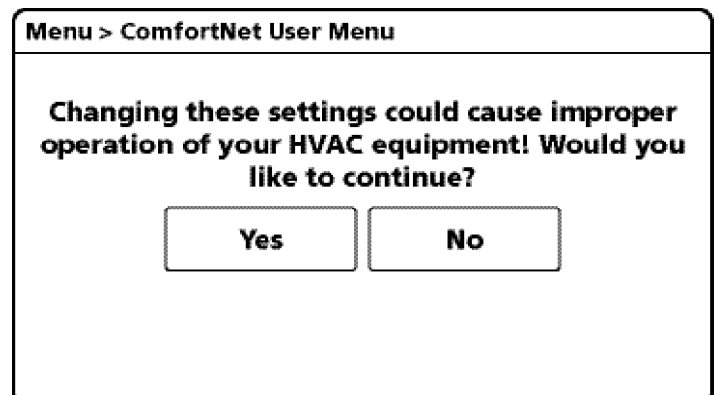

SERVICING

5. Select HEAT PUMP.

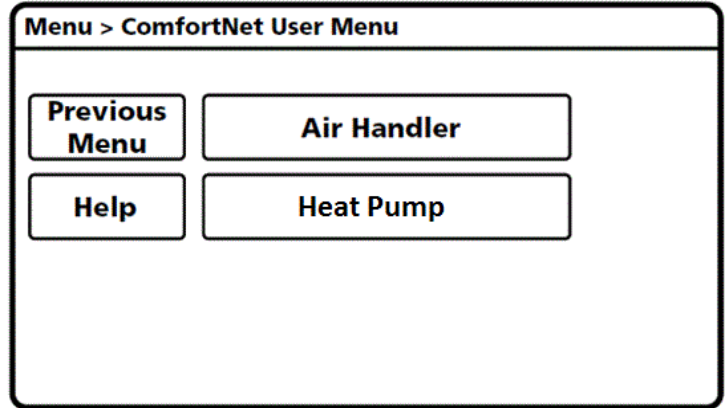

6. Select EQUIP TEST.

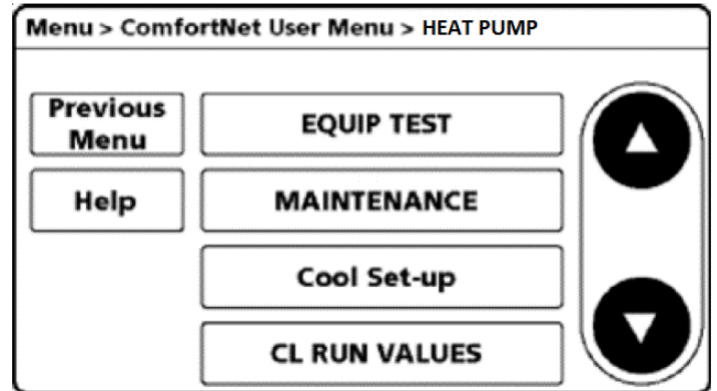

7. Select FORCE DF CYCLE.

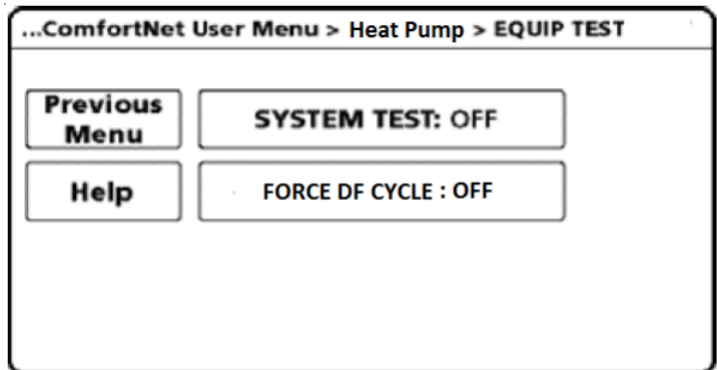

8. Select ON. Press DONE to initiate FORCE DEFROST CYCLE.

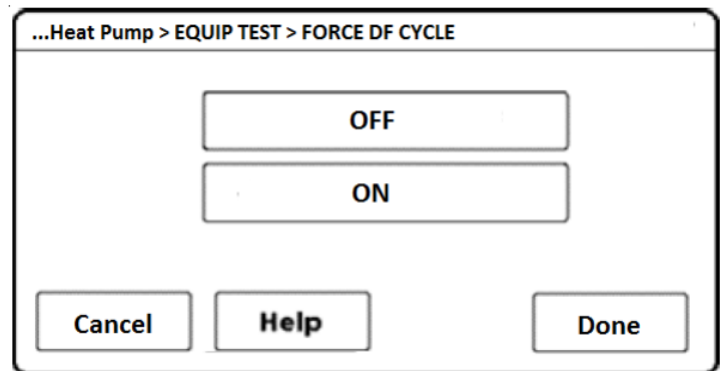

SERVICING

SET THERMOSTAT TO PUMP DOWN

Please follow the following sequence to enter PUMP DOWN to accumulate the refrigerant to outdoor unit. Do not operate Cool ON or Heat ON mode to enter PUMP DOWN. Before starting the PUMP DOWN operation, change indoor fan trim, delay and profile back to default and stop electric heater and gas furnace. Remove if no trim feature. In this operation, the gas valve and liquid service valve should be opened.

NOTE: Manufacturer recommends to set PUMP DOWN using 7-segment display. For more information, see section Set 7-segment mode display to PUMP DOWN. If difficulty is encountered using 7-segment display, use the thermostat as an alternative method. See section SET 7-SEGMENT MODE DISPLAY TO PUMP DOWN.

1. On the HOME screen, select MENU.

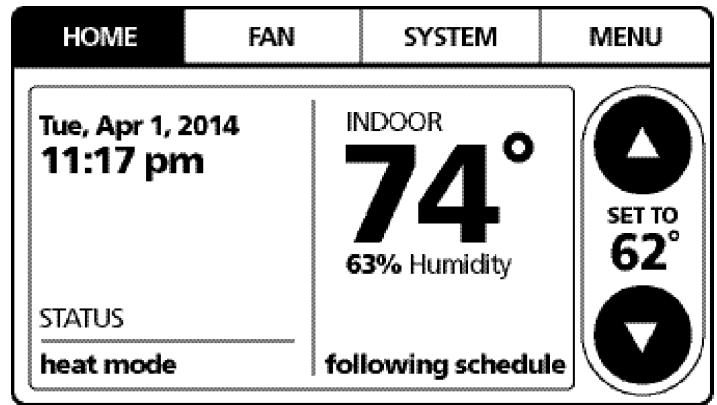

2. From the MENU screen, select COMFORTNET™ USER MENU.

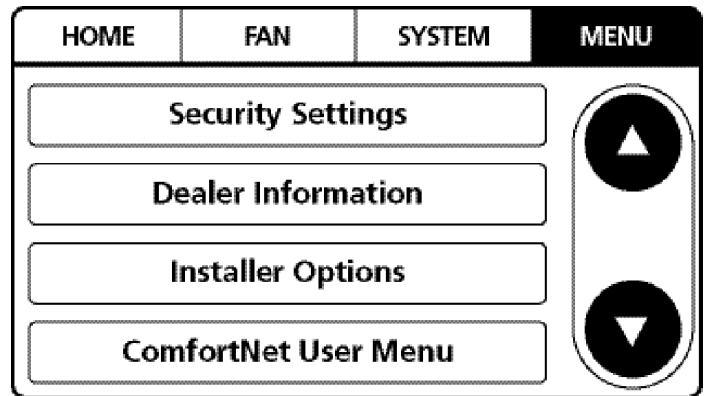

3. Enter installer password. (The password is the Date Code located on the thermostat and is available by entering the equipment status menu and scrolling to the bottom.)

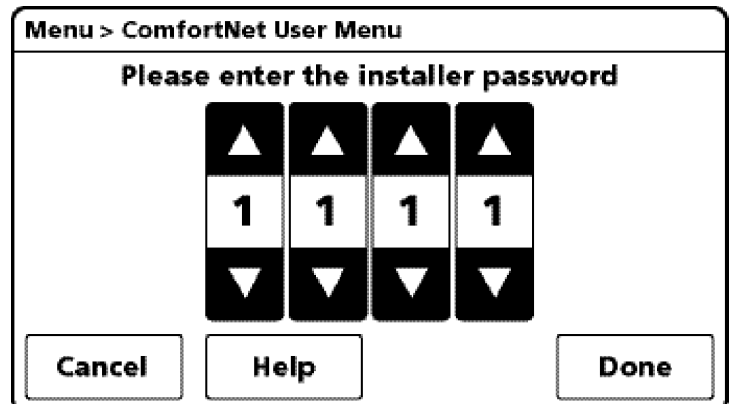

SERVICING

4. Select YES to continue.

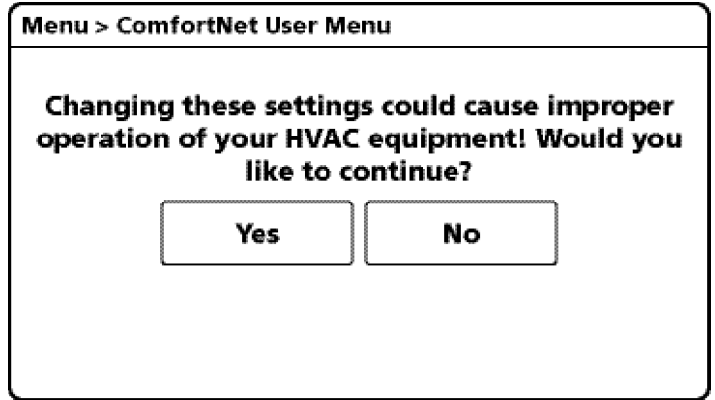

5. Select HEAT PUMP .

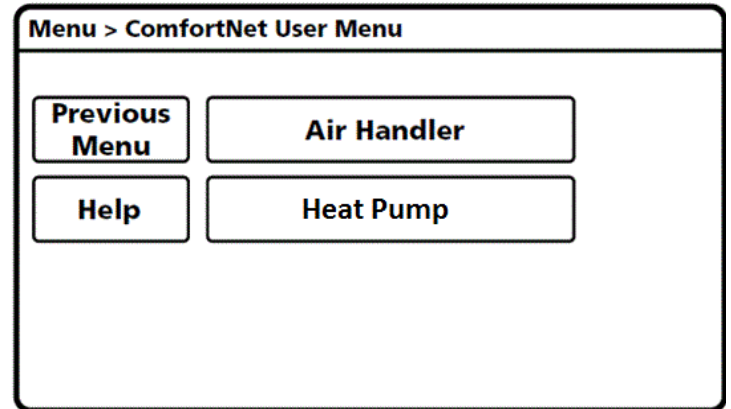

6. Select MAINTENANCE.

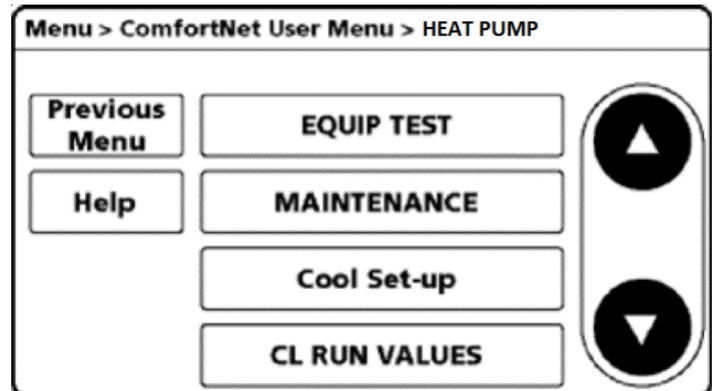

7. Select PUMP DOWN.

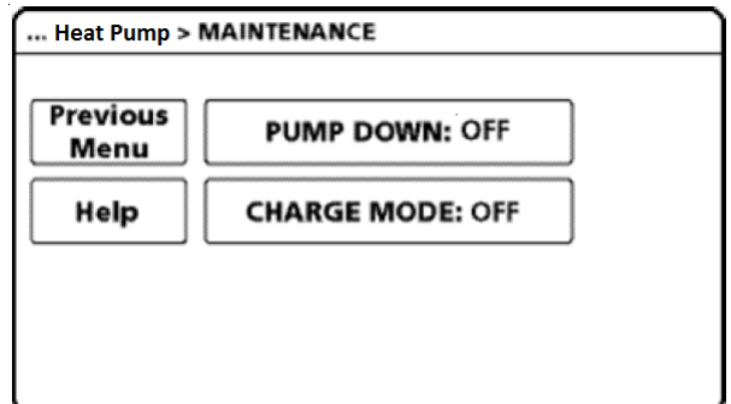

SERVICING

8. Select ON. Press DONE to initiate PUMP DOWN. Approximately one minute later, the compressor should start operating. Check the amperage at the compressor wiring to see the compressor operation status. Close liquid service valve approximately two minutes after compressor has come on. Compressor will stop automatically then close the gas service valve immediately.

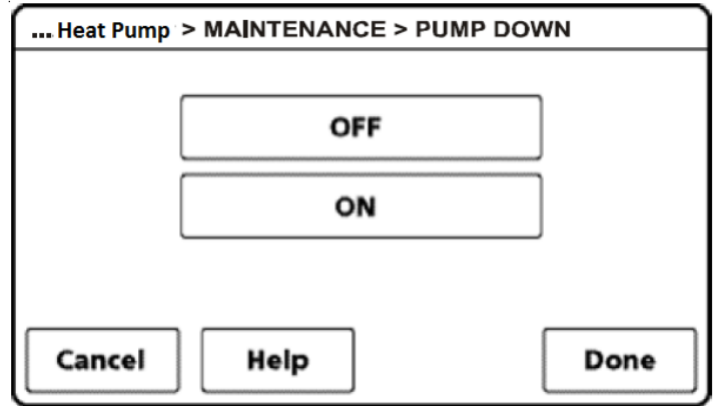

9. To terminate PUMP DOWN, select PUMP DOWN screen again. Press OFF. Press DONE to terminate PUMP DOWN.

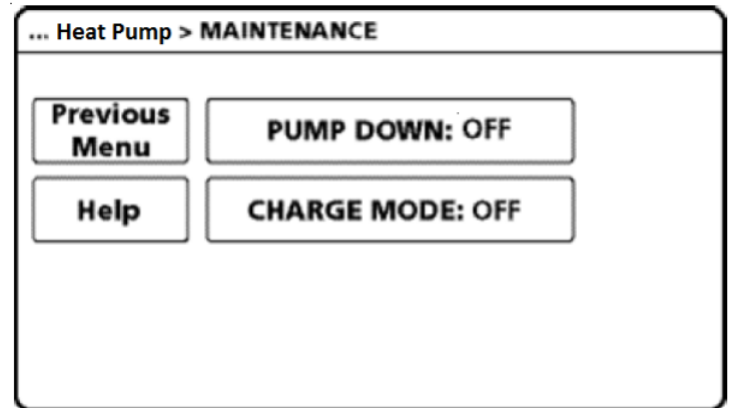

10. Once PUMP DOWN is set, navigate to HOME screen. After finishing PUMP DOWN operation, unit will stop automatically. Unit will show error code "E11" after the PUMP DOWN operation starts.

NOTE: Refrigerant cannot be collected to the outdoor unit completely if the system is overcharged or if there is a delay in closing the liquid service valve and gas service valve. Evacuate the leftover refrigerant from the system using a recovery machine.

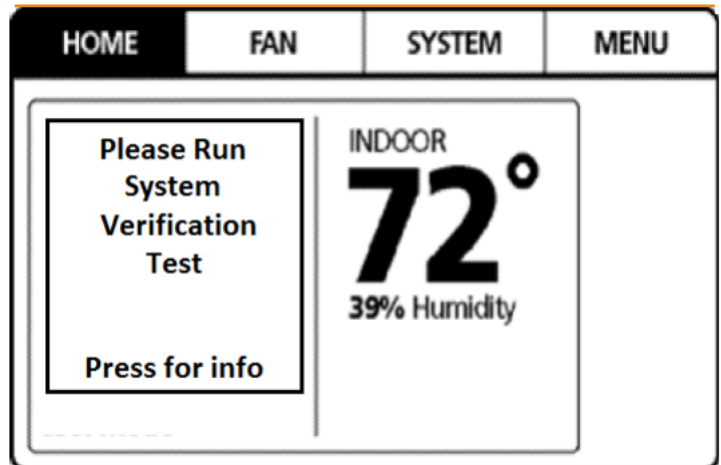

SERVICING

SET 7-SEGMENT MODE DISPLAY TO PUMP DOWN

Please follow the following sequence to enter PUMP DOWN to accumulate the refrigerant to outdoor unit. Do not operate COOL ON or HEAT ON mode to enter PUMP DOWN. Before starting the PUMP DOWN operation, change indoor fan trim, delay and profile back to default and stop electric heater and gas furnace. Remove if no trim feature. In this operation, the gas and liquid service valve should be opened.

1. Set 7-segment display to SCREEN 4 (SETTING MODE 2) Setting No. 8 and change the display from “-01” to “-00”. System will then automatically start PUMP DOWN operation.
For information on how to set 7-segment display, see the section SETTING THE MODE DISPLAY in this manual.
2. Approximately one minute later, the compressor should start operating. Check the amperage at the compressor wiring to see the compressor operation status. Unit display error code E11 (System verification Test) once the PUMP DOWN operations starts.
3. Close liquid service valve approximately two minutes after compressor has come on.
4. Compressor will come to a stop automatically. Close the suction service valve immediately after the compressor stops. After completion of PUMP DOWN, unit shows error code “E11”.

NOTE: Refrigerant cannot be collected to the outdoor unit completely if the system is overcharged or if there is a delay in closing the liquid service valve and suction service valve. Evacuate the left over refrigerant from the system using a recovery machine.

SET THERMOSTAT TO CHECK SYSTEM STATUS

1. Follow the sequence 1. to 5. of Set Thermostat to Adjust Indoor Air CFM trim.
2. Select STATUS.

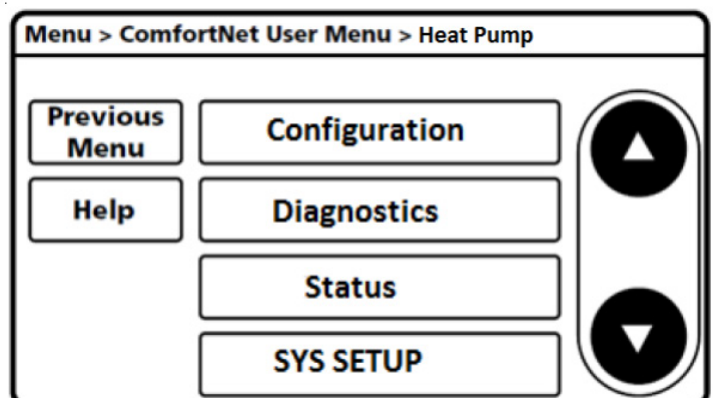

SERVICING

3. Follow screen for System Status.

TS	Time Stamp (Compressor run time)
MD	Current system operational Mode (cooling, cooling startup, heating, heating startup, oil return, defrost, stop)
CRM	Compressor Reduction Mode
RAD	Requested and Actual percentage Demand (Requested Demand, Actual cooling/heating provided)
RAF	Requested and Reported ID airflow (Requested CFM, Actual CFM)
ATOF*	Outdoor Air Temperature, Outdoor Fan speed (OD air temperature, OD Fan RPM)
DCT	Discharge Temperature, Outdoor Coil Temperature
DLT	Defrost sensor temperature, Outdoor Liquid Temperature
PSDST**	Pressure sensor reading Suction Pressure (cooling mode) Discharge pressure (heating mode)

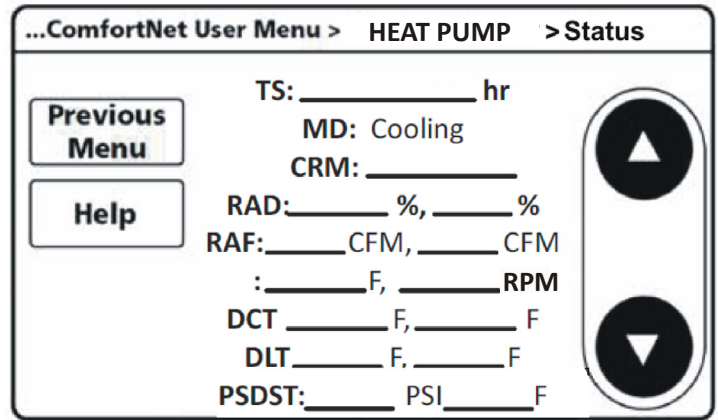

* Only for *VZC20**1AB or later revision.
 ATPRM is shown in *VZC20**1AA revision.
 ** Only for *VZC20**1AB or later revision.
 PSD is shown in *VZC20**1AA revision.

HEAT PUMP WITH OUTDOOR TEMPERATURE LOCKOUTS

It is recommended to set the outdoor temperature lockouts during the initial thermostat set up. This will enable the compressor to be turned off and switch heating source from refrigeration to auxiliary/secondary heating under low ambient conditions.

Line set length range (feet)	Compressor lockout temperature (°F)
0 to 100	15
100 to 200	20

For example if the line set is 125 feet, it is recommended to set the compressor lockout temperature at 20 °F during initial set up. In order to access the compressor lockout temperature, Press MENU and scroll down to press INSTALLER OPTIONS. Enter the date code (password) when prompted. Choose VIEW / EDIT CURRENT SETUP and COMPRESSOR LOCKOUT / BALANCE POINT will be under HEAT / COOL CONTROL OPTIONS. For more information please refer to COMFORTNET™ CTK04 Communicating Thermostat SYSTEM INSTALLATION GUIDE.

SERVICING

TROUBLESHOOTING - INDOOR UNIT FOR EEV APPLICABLE UNIT

DIRECTIONS TO COMFORTNET SYSTEM ADVANCED FEATURE MENUS

Press MENU, scroll down and press COMFORTNET USER MENU. Enter the date code (password) when prompted. The date code is printed on the back of the thermostat; or press MENU>EQUIPMENT STATUS and scroll down to find the date code. After you enter the date code, select air handler to view the system menus.

DIAGNOSTICS

Accessing the air handler's diagnostics menu provides ready access to the most recent six faults detected by the air handler. Faults are stored most recent to least recent. Any consecutively repeated fault is stored a maximum of three times. Example: A clogged return air filter causes the air handler's motor to repeatedly enter a limiting condition. The control will only store this fault the first three consecutive times the fault occurs.

NOTE: It is highly recommended that the fault history be cleared after performing maintenance or servicing the air handler.

IDENTIFICATION

The identification menu displays the model number, serial number and control software revision for the equipment. A model number check will help determine if the equipment shared data is correct for the unit (if the model number is not correct for the air handler, a Bluetooth® Shared Data Loader BTSDL01 will be required to load the proper data).

DIAGNOSTICS		
Submenu Item	Indication/User Modifiable Options	Comments
Fault 1 (FAULT #1)	Most recent fault	For display only
Fault 2 (FAULT #2)	Next most recent fault	For display only
Fault 3 (FAULT #3)	Next most recent fault	For display only
Fault 4 (FAULT #4)	Next most recent fault	For display only
Fault 5 (FAULT #5)	Next most recent fault	For display only
Fault 6 (FAULT #6)	Least recent fault	For display only
Clear Faults (CLEAR)	NO or YES	Selecting "YES" clears the fault history

NOTE: Consecutively repeated faults are shown a maximum of 3 times.
ADVANCED FEATURES DIAGNOSTICS MENU CHART

IDENTIFICATION	
Submenu Item	Indication (for Display Only; not User Modifiable)
Model Number (MOD NUM)	Displays the air handler model number
Serial Number (SER NUM)	Displays the air handler serial number (Optional)
Software Version (SOFTWARE)	Displays the application software revision

ADVANCED FEATURES IDENTIFICATION MENU CHART

SET-UP

SET-UP		
Submenu Item	User Modifiable Options	Comments
HUM	OFF*, ON, IND	Choose the operation mode of Humidifier (This selection is only displayed if HUM is selected in ACC)
HUM FAN SPD (%)	25%, 50%*, 75% , 100%	Choose the indoor fan speed at the time of humidification (This selection is only displayed if IND is selected in HUM and HUM is selected in ACC)
ACC	HUM, W/BLWR, NONE*	Choose Accessory (Humidifier, any other accessory requiring blower or none)
HT KIT (kW)	All valid HT options	Chose valid heater kit installed (Default setting is set to 'no heater kit')
Heat Airflow Trim (%) (HT TRM)	0*, 2, 4, 6, 8, 10	Trims the heating airflow by the selected amount

Note: Default factory settings are marked with *.

The set-up menu allows for selecting accessories that may have been connected to the indoor unit. User can choose between Humidifier, W/BLWR for an accessory which is run in conjunction with the blower or none if no accessory is connected. HUM (Humidity Setting) selection is only displayed if HUM is selected in ACC. User can choose the operation mode of Humidifier. HUM FAN SPD (Humidity Airflow) selection is only displayed if IND is selected in HUM and HUM is selected in ACC. User can choose the indoor fan speed trim at the time of humidification. Heater kit selection can also be done from this menu. It is very important to select the correct heater kit value for normal operation of the system. The set-up menu allows for selecting the trim adjustment of nominal electric heat airflow from 0% to 10% (in 2% incremental steps).

Status

This menu displays information about the systems current status. This menu can be utilized to confirm correct functionality of the equipment and for troubleshooting purposes. It can also be used to compare measured airflow values to the value reported by the air handler.

Current Mode: Current system operational mode (COOL, HEAT, FAN, AUX HEAT, DEFROST, ON).
 Current Airflow: Indoor unit airflow (CFM)
 Liq Gas Temp: ID coil inlet temp, ID coil outlet temp (cooling mode)
 ID coil outlet temp, ID coil inlet temp (heating mode)
 Pressure: Indoor coil pressure sensor reading
 Refrigerant: R-410A
 SH and SC: ID super heat (cooling mode), ID subcooling (heating mode)
 Fan Run Time: Provides ID fan run time in hours

Menu > ComfortNet User Menu>Air Handler>Status

Previous Menu

Help

Current Mode:
Current Airflow:
LIQ GAS TEMP:
PRESSURE:
REFRIGERANT
SH and SC:
FAN RUN TIME:

SERVICING

HEAT PUMP ADVANCED FEATURE MENU

DIAGNOSTICS		
SUBMENU ITEM	INDICATION/USER MODIFIABLE OPTIONS	COMMENTS
Clear Faults	NO or YES	Selecting "YES" clears the fault history.
Fault 1	Most recent HP fault	
Fault 2	2nd most recent HP fault	
Fault 3	3rd most recent HP fault	
Fault 4	4th most recent HP fault	
Fault 5	5th most recent HP fault	
Fault 6	6th most recent HP fault	

STATUS	
SUBMENU ITEM	COMMENTS
Time Stamp (TS)	Provides compressor run time in hours.
Mode (MD)	Current system operation mode (COOLING, COOLING STARTUP, HEATING, HEATING STARTUP, DEFROST, OIL RETURN, STOP).
Compressor Reduction Mode (CRM)	Displays ON or OFF status. ON indicates that the reduction mode is operating and the compressor is running at a lower speed than the cooling load would normally require.
Requested and Actual % Demand (RAD)	Displays a 0-100% value, based on a ratio of the requested cooling demand to what the system is actually providing.
Requested and Reported ID CFM (RAF)	Compares the requested indoor airflow to what the indoor equipment has reported.
Outdoor Air Temperature and Outdoor Fan RPM (ATOF*)	Displays the outdoor air temperature as well as the outdoor fan speed (RPM).
Discharge Temperature and Outdoor Coil Temperature (DCT)	Displays the discharge temperature and outdoor coil temperature sensor readings.
Defrost sensor and Outdoor Liquid Temperature (DLT)	Displays the defrost temperature sensor and outdoor liquid temperature sensor reading.
Pressure Sensor (PSDST**)	Displays the pressure sensor reading which is taken slightly upstream of the suction accumulator.

* Only for *VZC20** or later revision. ATPRM is shown in *VZC20** revision.

** Only for *VZC20** or later revision. PSD is shown in *VZC20** revision.

HEAT PUMP ADVANCED FEATURE MENU

SYSTEM SETUP (SYS SETUP)		
SUBMENU ITEM	USER MODIFIABLE OPTIONS	COMMENTS
Reset System Setup Options to Factory Defaults	NO or YES	Selecting "YES" resets this menu to factory default settings.
SET MAX CURRENT	N/A	Future use.
VERTICAL RISE	Same Level, Outdoor Lower, or Indoor Lower	If the outdoor & indoor units are within +/- 15 ft. vertical distance, select SAME LEVEL. If the outdoor unit is more than 15 ft. below the indoor unit, select OUTDOOR LOWER. If the outdoor unit is more than 15 ft. above the indoor unit, select INDOOR LOWER.
BOOST MODE (BOOST MD)	ON or OFF	BOOST MD turns BOOST MODE OFF or ON. BOOST MODE is ON by default. See BOOST MODE section of this manual for more details.
BOOST MODE TEMPERATURE (BOOST TEMP)	Always ON, 70, 75, 80, 85, 90, 95, 100, 105F	BOOST TEMP adjusts the activation temperature from 70°F to 105°F. An "Always ON" option is also available to permanently engage BOOST MODE.

EQUIPMENT TEST (EQUIP TEST)		
SUBMENU ITEM	INDICATION/USER MODIFIABLE OPTIONS	COMMENTS
System Verification Test (SYSTEM TEST)	ON or OFF	System Verification Test must be run after installation. This is approximately a 5-15 minute test. If the thermostat is set to COOL mode, the system will enter CHARGE mode upon completion, otherwise it will stop.
Force Defrost Cycle (FORCE DF CYCLE)	ON or OFF	This will make the unit run in defrost mode.

SYSTEM MAINTENANCE		
SUBMENU ITEM	USER MODIFIABLE OPTIONS	COMMENTS
PUMP DOWN	ON or OFF	Enter PUMP DOWN Mode. This procedure runs the equipment for approximately 15 minutes and allows accumulation of refrigerant at the outdoor unit for purposes of removing & replacing the indoor unit or outdoor unit.
CHARGE MODE	ON or OFF	Enter Charging Mode. This allows for a steady system operation for a duration of approximately 1 hour to allow for refrigerant charging of the system via the suction charge port. The system will stop after completion.

NOTE: BOOST MODE is applicable only for *VZC20AB or later revision.

HEAT PUMP ADVANCED FEATURE MENU

COOL SETUP		
SUBMENU ITEM	USER MODIFIABLE OPTIONS	COMMENTS
CL Reset (CL RESET)	YES or NO	Selecting to default factory setting.
Cool Airflow Trim Hi ^{*1, *2} (C TR H)	-15% to +15% in 5% increments	Selects the cooling airflow trim amount.
Cool Airflow Trim Int (C TR I)	-15% to +20% in 5% increments, 30%, Full ^{*3}	Selects the cooling airflow trim amount.
Cool Airflow Trim Low (C TR L)	-15% to +20% in 5% increments, 30%, Full ^{*3}	Selects the cooling airflow trim amount.
Cool Airflow Profile (CL PRFL)	A, B, C, or D	Selects the cooling air low profile.
Cool ON Delay (CL ON)	5, 10, 20, 30 seconds	Selects the indoor blower ON delay.
Cool OFF Delay (CL OFF)	30, 60, 90, 120 seconds	Selects the indoor blower OFF delay.
Dehumidification Select (DEHUM)	STD, OFF, A, B or C	Selecting "OFF" disables dehumidification; selecting "STD", "A", "B" or "C" enables dehumidification. ^{*4}

SET COOLING RUN VALUES (CL RUN VALUES)		
SUBMENU ITEM	USER MODIFIABLE OPTIONS	COMMENTS
Maximum Compressor RPS Range for Cooling (COOL RPS RANGE)	Five different compressor RPS ranges will be provided.	Select the appropriate range for the installed system configuration.
Maximum Compressor RPS Selection for Cooling (COOL RPS SELECT)	10 compressor RPS values will be provided within the range selected in the COOL RPS RANGE menu	Select the appropriate compressor RPS for the installed system configuration.

HEAT SETUP		
SUBMENU ITEM	USER MODIFIABLE OPTIONS	COMMENTS
HT Reset (HT RESET)	YES or NO	Selecting to default factory setting.
Heat Airflow Trim Hi ^{*1} (H TR H)	-15% to +15% in 5% increments	Selects the heating airflow trim amount.
Heat Airflow Trim Int (H TR I)	-15% to +15% in 5% increments	Selects the heating airflow trim amount.
Heat Airflow Trim Low (H TR L)	-15% to +15% in 5% increments	Selects the heating airflow trim amount.
Heat ON Delay (HT ON)	5, 10, 15 seconds	Selects the indoor blower ON delay.
Heat OFF Delay (HT OFF)	30, 50, 70, 90 seconds	Selects the indoor blower OFF delay.
Maximum Defrost Interval (DEFROST)	30 mins., 1 hr., 1.5 hrs. & 2 hrs.	Selects time defrost interval

SET HEATING RUN VALUES (HT RUN VALUES)		
SUBMENU ITEM	USER MODIFIABLE OPTIONS	COMMENTS
Maximum Compressor RPS Range for Heating (HEAT RPS RANGE)	Five different compressor RPS ranges will be provided.	Select the appropriate range for the installed system configuration.
Maximum Compressor RPS Selection for Heating (HEAT RPS SELECT)	10 compressor RPS values will be provided within the range selected in the HEAT RPS RANGE menu	Select the appropriate compressor RPS for the installed system configuration.

NOTE: The specification of *VZC200241AF, 0361AE, 0481AE and 0601AE or earlier models are different from this specification. For details, see the Installation Manual or Service Manual that matches the Major and Minor revision of model name.

*1 *VZC200601* with **VC960804C, **VM970804C and *MVC800804C combination trim more than 5% settings are invalid. Trimmed up CFM makes mismatching error.

*2 Other than the above, depending on the connected indoor unit, there are restrictions on the positive side Trim setting.

If you want to change the Cool Airflow Trim to positive side, be sure to confirm the Airflow Trim restrictions in the latest indoor unit installation manual. The latest manual can be obtained from the website "PartnerLink(InfoFinderPlus/Literature)".

[PartnerLink URL]

<https://partnerlinkmarketing.goodmanmfg.com/goodman/info-finder-plus>

*3 The Inverter system uses lower compressor speed and lower indoor unit CFM to optimize system performance.

To obtain 100% CFM for home circulation, use full Trim setting instead of Int/Low speed.

This is recommended for applications with unusually cold return temperatures such as basements.

*4 Please refer to the page of "DEHUMIDIFICATION SELECT" for details of this function.

TROUBLESHOOTING

COOLING ANALYSIS CHART

POSSIBLE CAUSE X IN ANALYSIS GUIDE INDICATE "POSSIBLE CAUSE"																			
	Comp discharge temp > 200F	Comp discharge temp < 105F	Comp discharge SH > 70F	Comp discharge SH < 20F	High pressure > 490psi	High pressure < 255psi	LSV SC > 12F	LSV SC < 4F	OD SSV SH > 20F	OD SSV SH < 4F	Low pressure > 185psi	Low pressure < 100psi	Requested % demand < Actual	Requested % demand > Actual	Repeated stop/start	Weak cooling	No switch cooling	Noise	Stop operation
Liquid stop valve does not fully open	X		X		X		X		X			X		X	X	X		X	
Gas stop valve does not fully open	X		X									X		X	X	X			
Line set restriction	X		X		X		X		X			X		X	X	X		X	
Line set length is too long									X			X			X	X		X	
Blocked filter-dryer	X		X		X		X		X			X		X	X	X		X	
OD EEV coil failure														X	X	X			X
OD EEV failure														X	X	X			
ID EEV coil failure	X	X	X	X	X	X	X	X	X	X	X	X	X	X	X	X			X
ID EEV failure	X	X	X	X	X	X	X	X	X	X	X	X	X	X	X	X			
Check valve failure – Blocked	X		X		X			X	X			X		X	X	X			
High Pressure switch failure																			X
Pressure sensor failure	X										X	X			X	X			X
Discharge temp sensor failure	X	X	X	X									X	X	X	X			X
Coil temp sensor failure				X	X	X							X	X	X	X			X
Defrost sensor failure																			
Liquid temp sensor failure																			
Ambient temp sensor failure				X	X	X							X	X	X	X			
OD recirculation	X		X		X									X	X	X		X	
ID recirculation		X		X					X			X	X	X	X	X			
Dirty OD Heat-exchanger	X		X		X					X				X	X	X			X
Dirty ID Heat-exchanger		X		X				X		X		X	X	X	X	X			
Outdoor Ambient temp is too high	X		X		X				X					X	X	X			X
Outdoor Ambient temp is too low		X		X		X	X					X	X	X	X	X			
ID suction temp is too high								X		X									
ID suction temp is too low		X		X				X		X		X	X	X	X	X			
Mixture of non-condensable gas	X		X		X			X	X			X		X	X	X			X
OD fan motor failure	X		X		X			X						X	X	X			X
RV failure	X		X			X					X			X	X	X	X		X
RV coil failure	X		X			X					X			X	X	X	X		X
Over charge	X	X	X	X	X		X			X			X			X			X
Under charge	X	X	X			X		X	X			X				X			X
Leak	X	X	X			X		X	X			X		X	X	X			X
TXV failure	X	X	X	X	X	X	X	X	X	X	X	X	X	X	X	X			
TXV is small	X		X		X		X		X			X				X			
TXV is big		X		X		X		X		X	X		X			X			
OD Control Board Failure																			X
ID Failure	X	X	X	X	X	X	X	X	X	X	X	X	X	X	X	X	X		X
Compressor failure	X	X	X			X					X			X	X	X			X
Cooling loop is not attached														X	X	X			
Cooling loop grease is not enough														X	X	X			
Compressor and Gas furnace are operating at the same time																			X
Low ID CFM		X		X						X		X	X	X	X	X			X

Outdoor Normal Temperature Operating Range: 67-115°F / Indoor Normal Temperature Operating Range: 65 - 85°F

WARNING

AVOID CONTACT WITH THE CHARGED AREA.

•NEVER TOUCH THE CHARGED AREA BEFORE CONFIRMING THAT THE RESIDUAL VOLTAGE IS 50 VOLTS OR LESS.

1. SHUT DOWN THE POWER AND LEAVE THE CONTROL BOX FOR 10 MINUTES.
2. MAKE SURE TO TOUCH THE EARTH GROUND TERMINAL TO RELEASE THE STATIC ELECTRICITY FROM YOUR BODY (TO PREVENT FAILURE OF THE PC BOARD).
3. MEASURE THE RESIDUAL VOLTAGE IN THE SPECIFIED MEASUREMENT POSITION USING A VOM WHILE PAYING ATTENTION NOT TO TOUCH THE CHARGED AREA.
4. IMMEDIATELY AFTER MEASURING THE RESIDUAL VOLTAGE, DISCONNECT THE CONNECTORS OF THE OUTDOOR UNIT'S FAN MOTOR. (IF THE FAN BLADE ROTATES BY STRONG WIND BLOWING AGAINST IT, THE CAPACITOR WILL BE CHARGED, CAUSING THE DANGER OF ELECTRICAL SHOCK.)

TROUBLESHOOTING

HEATING ANALYSIS CHART

POSSIBLE CAUSE X IN ANALYSIS GUIDE INDICATE "POSSIBLE CAUSE"	Comp discharge temp > 200F	Comp discharge temp < 105F	Comp discharge SH > 70F	Comp discharge SH < 20F	High pressure > 490psi	High pressure SSV < 270psi	High pressure LSV < 270psi	LSV SC > 12F	LSV SC < 4F	Low pressure < 40psi	Requested % demand < Actual %	Requested % demand > Actual %	Repeated stop/start	Weak heating	No switch heating	Noise	Incomplete defrost operation	Stop operation	Sweating liquid line
	Liquid stop valve does not fully open	X		X		X			X		X		X	X	X			X	
Gas stop valve does not fully open	X		X		X				X	X		X	X	X			X		
Line set restriction	X		X		X				X	X		X	X	X			X		X
Line set length is too long					X		X												X
Blocked filter-dryer	X		X		X				X	X		X	X	X			X		X
OD EEV coil failure	X	X	X	X	X	X	X	X	X	X	X	X	X	X			X	X	
OD EEV failure	X	X	X	X	X	X	X	X	X	X	X	X	X	X			X	X	
ID EEV coil failure	X		X		X		X		X	X	X	X	X	X			X	X	X
ID EEV failure	X		X		X		X		X	X	X	X	X	X			X	X	X
Check valve failure – Leakage		X		X					X		X		X	X				X	
High Pressure switch failure																		X	
Pressure sensor failure			X	X	X	X	X	X	X		X	X	X	X				X	
Discharge temp sensor failure	X	X	X	X							X	X	X	X				X	
Coil temp sensor failure										X		X	X	X			X	X	
Defrost sensor failure										X		X	X	X			X	X	
Liquid temp sensor failure								X	X									X	X
Ambient temp sensor failure					X					X		X	X	X				X	X
OD recirculation	X		X			X	X			X		X	X	X					
ID recirculation	X		X		X							X	X	X					
Dirty OD Heat-exchanger	X		X			X	X			X		X	X	X					
Dirty ID Heat-exchanger	X		X		X							X	X	X					
Outdoor Ambient temp is too high					X							X	X	X				X	X
Outdoor Ambient temp is too low	X	X	X			X	X		X	X		X	X	X					
ID suction temp is too high	X				X							X	X	X					
ID suction temp is too low						X	X												X
Mixture of non-condensable gas	X		X		X				X	X		X	X	X					
OD fan motor failure	X		X							X		X	X	X				X	
RV failure			X			X	X					X	X	X	X		X	X	
RV coil failure			X			X	X					X	X	X	X		X	X	
Over charge			X	X	X			X			X	X	X	X				X	X
Under charge	X	X	X			X	X		X	X			X	X					X
Leak	X	X	X			X	X		X	X			X	X					X
TXV failure	X		X		X				X	X		X	X	X					
TXV size is small																			X
TXV size is big																			
ID failure	X	X	X	X	X	X	X	X	X	X	X	X	X	X		X	X	X	X
OD Control Board failure																		X	
Compressor failure	X	X	X	X		X	X					X	X	X		X	X	X	
Cooling loop is not attached												X	X	X					
Cooling loop grease is not enough												X	X	X					
Compressor and Gas furnace are operating at the same time																		X	X
Low ID CFM	X				X				X			X	X	X				X	

Outdoor Normal Temperature Operating Range: 17-62°F / Indoor Normal Temperature Operating Range: 65 - 85°F

WARNING

AVOID CONTACT WITH THE CHARGED AREA.

•NEVER TOUCH THE CHARGED AREA BEFORE CONFIRMING THAT THE RESIDUAL VOLTAGE IS 50 VOLTS OR LESS.

1. SHUT DOWN THE POWER AND LEAVE THE CONTROL BOX FOR 10 MINUTES.
2. MAKE SURE TO TOUCH THE EARTH GROUND TERMINAL TO RELEASE THE STATIC ELECTRICITY FROM YOUR BODY (TO PREVENT FAILURE OF THE PC BOARD).
3. MEASURE THE RESIDUAL VOLTAGE IN THE SPECIFIED MEASUREMENT POSITION USING A VOM WHILE PAYING ATTENTION NOT TO TOUCH THE CHARGED AREA.
4. IMMEDIATELY AFTER MEASURING THE RESIDUAL VOLTAGE, DISCONNECT THE CONNECTORS OF THE OUTDOOR UNIT'S FAN MOTOR. (IF THE FAN BLADE ROTATES BY STRONG WIND BLOWING AGAINST IT, THE CAPACITOR WILL BE CHARGED, CAUSING THE DANGER OF ELECTRICAL SHOCK.)

TROUBLESHOOTING

Fault Code	Control Board LED Display	Transmitted Climate Talk Message	Thermostat Fault	Probable Causes	Corrective Actions
12	E12	OD CTRL FAIL1	Indicates a general memory error.	<ul style="list-style-type: none"> High electrical noise Faulty control board 	<ul style="list-style-type: none"> Replace control board if necessary
13	E13	HI PRESSURE C (C = CRITICAL)	This error indicates the equipment is experiencing frequent high pressure faults.	<ul style="list-style-type: none"> Blocked/restricted condenser coil and/or lines Stop valve not completely open Overcharge Outdoor fan not running High pressure switch (HPS) inoperable Faulty TXV Faulty control board 	<ul style="list-style-type: none"> Check and clean condenser coil and/or lines Check the opening of stop valve, should be full open; Repair/replace if needed Check refrigerant charge level; Adjust if needed Check outdoor fan motor & wiring; Repair/replace if needed Check TXV; Replace if needed Replace control board if necessary
14	-	HI PRESSURE M (M = MINOR)	This error indicates the equipment is experiencing frequent high pressure faults. Control has determined continued operation is acceptable. This indicates they may be a problem with the equipment.	<ul style="list-style-type: none"> Blocked/restricted condenser coil and/or lines Stop valve not completely open Overcharge Outdoor fan not running High pressure switch (HPS) inoperable Faulty TXV Faulty control board 	<ul style="list-style-type: none"> Check and clean condenser coil and/or lines Check the opening of stop valve, should be full open; Repair/replace if needed Check refrigerant charge level; Adjust if needed Check outdoor fan motor & wiring; Repair/replace if needed Check TXV; Replace if needed Replace control board if necessary Check high pressure switch; Replace if necessary
15	E15	LOW PRESSURE C	This error indicates the equipment is experiencing frequent low pressure faults.	<ul style="list-style-type: none"> Stop valve not completely open Restriction in refrigerant lines Low refrigerant charge Refrigerant leak Low pressure sensor inoperable or not properly connected Indoor fan motor not functioning correctly Faulty TXV Faulty control board 	<ul style="list-style-type: none"> Check the opening of stop valve, should be full open; Repair/replace if needed Check for restrictions in refrigerant line; Repair/replace if needed Check refrigerant charge level; Adjust if needed Test for system leaks using leak test procedure Check the connection to low pressure sensor; Repair/replace if needed Check TXV; Replace if needed Check indoor blower motor & wiring; Repair/replace if needed Replace control board if necessary
16	-	LOW PRESSURE M	This error indicates the equipment is experiencing frequent low pressure faults. Control has determined continued operation is acceptable. This indicates they may be a problem with the equipment.	<ul style="list-style-type: none"> Stop valve not completely open Restriction in refrigerant lines Low refrigerant charge Refrigerant leak Low pressure sensor inoperable or not properly connected Indoor fan motor not functioning correctly Faulty TXV Faulty control board 	<ul style="list-style-type: none"> Check the opening of stop valve, should be full open; Repair/replace if needed Check for restrictions in refrigerant line; Repair/replace if needed Check refrigerant charge level; Adjust if needed Test for system leaks using leak test procedure Check the connection to low pressure sensor; Repair/replace if needed Check TXV; Replace if needed Check indoor blower motor & wiring; Repair/replace if needed Replace control board if necessary
17	E17	COMPRESSOR FAIL	This error indicates the equipment is experiencing frequent compressor faults.	<ul style="list-style-type: none"> Stop valve not completely open The compressor wire is lost phase Compressor motor failure 	<ul style="list-style-type: none"> Check the opening of stop valve, should be full open; Repair/replace if needed Check the wire between control board and compressor Inspect compressor motor for proper function; Replace if necessary
18	E18	OD CTRL FAIL2	Indicates the control board may need to be replaced.	<ul style="list-style-type: none"> Outdoor fan motor not connected properly Faulty control board Noise 	<ul style="list-style-type: none"> Check wiring from Outdoor fan motor to control board; Repair if needed. Replace control board if necessary
19	E19	PCB OR FAN FAIL	This error indicates the equipment is experiencing frequent outdoor control board and/or motor faults.	<ul style="list-style-type: none"> Obstruction in fan rotation Outdoor fan motor not connected properly Outdoor fan not running Faulty control board Noise 	<ul style="list-style-type: none"> Check and clean grille or any debris Check wiring from Outdoor fan motor to control board; Repair if needed Check outdoor fan motor & wiring; Repair/replace if needed Replace control board if necessary
20	E20	EEV OPEN CKT	EEV coil is not connected.	<ul style="list-style-type: none"> Outdoor EEV coil is not connected. Faulty outdoor EEV coil. 	<ul style="list-style-type: none"> Check outdoor EEV coil connection. Repair/replace as needed.
21	E21	EEV CTRL FAIL	This error indicates the equipment is experiencing frequent low discharge superheat faults.	<ul style="list-style-type: none"> Thermistors inoperable or improperly connected Faulty TXV Faulty outdoor EEV coil Faulty indoor EEV Over charge Faulty pressure sensor Faulty control board 	<ul style="list-style-type: none"> Check the connection to thermistors; Repair/replace if needed Check TXV; Replace/repair if needed Check outdoor EEV coil; Repair/replace if needed Check outdoor EEV; Replace/repair if needed Check refrigerant charge level; Adjust if needed Check pressure sensor; Repair/replace if needed Replace control board if necessary

(*1) This message displayed when using the CTKO4 thermostat.

(*2) This specification of *VZC20*1 or earlier model are different from this specification. For details, see the service manual that matches the major revision of model name.

TROUBLESHOOTING

Fault Code	Control Board LED Display	Transmitted Climate Talk Message	Thermostat Fault	Probable Causes	Corrective Actions
22	E22	HI DISCH TEMP	This error indicates the equipment is experiencing frequent high discharge temperature faults. Discharge thermistor is not put on correct position.	<ul style="list-style-type: none"> Discharge thermistor inoperable or improperly connected Discharge thermistor is put on incorrect position or off Low refrigerant charge Overcharge Faulty compressor 	<ul style="list-style-type: none"> Check discharge thermistor resistance and connections; Repair/replace as needed Check discharge thermistor position Check refrigerant charge level; Adjust if needed Check the compressor; Repair/replace if needed
23	E23	DISCH TEMP FAIL	The control has detected that the Discharge Temperature Sensor is out of range.	<ul style="list-style-type: none"> Discharge thermistor inoperable or improperly connected 	<ul style="list-style-type: none"> Check discharge thermistor resistance and connections; Repair/replace as needed
24	E24	HPS OPEN	The high pressure switch is open.	<ul style="list-style-type: none"> High pressure switch (HPS) inoperable 	<ul style="list-style-type: none"> Check resistance on HPS to verify operation; Replace if needed
25	E25	AIR SENSOR FLT	The outdoor air temperature sensor is open or shorted.	<ul style="list-style-type: none"> Faulty outdoor thermistor sensor or disconnect 	<ul style="list-style-type: none"> Inspect and test sensor; Replace sensor if needed
26	E26	PRESSURE SENSOR	The control determines that the pressure sensor is not reacting properly.	<ul style="list-style-type: none"> Low pressure sensor inoperable or not properly connected 	<ul style="list-style-type: none"> Check the connection to low pressure sensor; Repair/replace if needed
27	E27	COIL TEMP FAIL1	The control detects that the Outdoor Defrost Sensor is out of range.	<ul style="list-style-type: none"> Outdoor defrost thermistor inoperable or not properly connected 	<ul style="list-style-type: none"> Check the connection to OD defrost thermistor; Repair as needed
28	E28	COIL TEMP FAIL2	The control has detected that the Outdoor Coil Temperature Sensor is out of range.	<ul style="list-style-type: none"> Outdoor coil thermistor inoperable or not properly connected 	<ul style="list-style-type: none"> Check the connection to OD coil thermistor; Repair/replace if needed
29	E29	LIQ TEMP FAIL	The control has detected that the Liquid Temperature Sensor is out of range.	<ul style="list-style-type: none"> Liquid thermistor inoperable or not properly connected 	<ul style="list-style-type: none"> Check the connection to liquid thermistor; Repair/replace if needed
30	E30	OD CTRL FAIL3	Indicates the control board may need to be replaced.	<ul style="list-style-type: none"> Wiring to control board disconnected Faulty control board Noise 	<ul style="list-style-type: none"> Check wiring to control board; Repair as needed Replace control board if necessary
31	E31	HI LEAK CURRENT	The control has detected high leakage current (high voltage).	<ul style="list-style-type: none"> Improper ground Faulty compressor 	<ul style="list-style-type: none"> Check ground screws/lugs and wiring; Repair/replace if needed Check the compressor; Repair/replace if needed
32* ²	E32	HI TEMP CTRL1	This error indicates the equipment is experiencing high temperature faults on the outdoor control board.	<ul style="list-style-type: none"> Ambient air conditions too high Cooling bracket screw(s) missing or not properly fastened (2-4 ton only) No or poor thermal grease coating between cooling plumbing and cooling bracket on control board (2-4 ton only) Outdoor fan low speed (5 ton only) No flow or limited flow through control board cooling circuit (potential restriction in line or low refrigerant) (2-4 ton only) Stop valve not completely open (2-4 ton only) 	<ul style="list-style-type: none"> Cycle power; re-try during usable ambient temperature range Verify cooling bracket screws in place and secure; Secure fasteners as needed (2-4 ton only) Check thermal grease inside cooling bracket on control board; Apply additional grease as needed Check outdoor fan motor & wiring; Repair/replace if needed (5 ton only) Check for restriction in line Check refrigerant charge level; Adjust if needed (2-4 ton only) Check the opening of stop valve, should be full open; Repair/replace if needed (2-4 ton only)
33* ²	-	HI TEMP CTRL2	This error indicates the equipment is experiencing high temperature faults on the outdoor control board. Control has determined continued operation is acceptable. This indicates they may be a problem with the equipment.	<ul style="list-style-type: none"> Ambient air conditions too high Cooling bracket screw(s) missing or not properly fastened (2-4 ton only) No or poor thermal grease coating between cooling plumbing and cooling bracket on control board (2-4 ton only) Outdoor fan low speed (5 ton only) No flow or limited flow through control board cooling circuit (potential restriction in line or low refrigerant) (2-4 ton only) Stop valve not completely open (2-4 ton only) 	<ul style="list-style-type: none"> Cycle power; re-try during usable ambient temperature range Verify cooling bracket screws are in place and secure; Secure fasteners as needed (2-4 ton only) Check thermal grease inside cooling bracket on control board; Apply additional grease as needed Check outdoor fan motor & wiring; Repair/replace if needed (5 ton only) Check for restriction in line Check refrigerant charge level; Adjust if needed (2-4 ton only) Check the opening of stop valve - it should be fully open; Repair/replace if needed (2-4 ton only)
34	E34	CURRENT SPIKE	Board detected a high current condition. This indicates the potential for a short circuit.	<ul style="list-style-type: none"> Current spike in supply Stop valve not completely open The compressor wire is lost phase Faulty control board Faulty compressor 	<ul style="list-style-type: none"> Check power supply for in-rush current during start-up or steady state operation Check the opening of stop valve, should be full open; Repair/replace if needed Check the wire between control board and compressor Replace control board if necessary Check the compressor; Repair/replace if needed

(*1) This message displayed when using the CTKO4 thermostat.

(*2) This specification of *VZC20*1 or earlier model are different from this specification. For details, see the service manual that matches the major revision of model name.

TROUBLESHOOTING

Fault Code	Control Board LED Display	Transmitted Climate Talk Message	Thermostat Fault	Probable Causes	Corrective Actions
35	E35	HIGH CURRENT	Board detected a high current condition.	<ul style="list-style-type: none"> Short circuit condition Stop valve not completely open Overcharge Faulty control board Faulty compressor 	<ul style="list-style-type: none"> Check installation clearances. Check the opening of stop valve, should be full open; Repair/replace if needed Check refrigerant charge level; Adjust if needed Replace control board if necessary Check the compressor; Repair/replace if needed.
36	E36	STARTUP ERROR	The control encountered an abnormal condition during the startup procedure.	<ul style="list-style-type: none"> Blocked/restricted condenser coil and/or lines The compressor wire is lost phase Inconsistent compressor load Faulty control board 	<ul style="list-style-type: none"> Check and clean condenser coil and/or lines Check the wire between control board and compressor Replace control board if necessary
37	E37	OD CTRL FAIL4	Indicates the control board may need to be replaced.	<ul style="list-style-type: none"> Outdoor fan motor not connected properly Faulty control board 	<ul style="list-style-type: none"> Check wiring from outdoor fan motor to control board; Repair if needed Replace control board if necessary
38	E38	COMP VOLTAGE	The control has detected a voltage related issue with the compressor.	<ul style="list-style-type: none"> High or low voltage from supply The compressor wire is lost phase Faulty control board 	<ul style="list-style-type: none"> Correct low/high line voltage condition; Contact local utility if needed Check the wire between control board and compressor Replace control board if necessary
39	E39	OD CTRL FAIL5	Indicates the control board may need to be replaced.	<ul style="list-style-type: none"> Thermistors inoperable or improperly connected Faulty control board 	<ul style="list-style-type: none"> Check the connection to thermistors; Repair/replace if needed Replace control board if necessary
40	E40	COMP MISMATCH	Control determines that its compressor requirement is different than the compressor capability.	<ul style="list-style-type: none"> Bluetooth® Shared Data Loader BTSDL01 not correct Control board mismatch 	<ul style="list-style-type: none"> Check Bluetooth® Shared Data Loader BTSDL01 data vs. air conditioner model Verify control board size vs. air conditioner model; Replace control board if necessary
41	E41	LOW REFRIGERANT	The control has detected a low refrigerant condition.	<ul style="list-style-type: none"> Refrigerant leak Low refrigerant charge Thermistors inoperable or not properly connected 	<ul style="list-style-type: none"> Test for system leaks using leak test procedure Check refrigerant charge level; Adjust if needed Check the connection to thermistor; Repair/replace if needed
42	E42	LOW LINE VOLT	Control detects a low power supply voltage condition.	<ul style="list-style-type: none"> Low line voltage supply 	<ul style="list-style-type: none"> Check circuit breakers and fuses; Replace if needed Verify unit is connected to power supply as specified on rating plate Correct low line voltage condition; Contact local utility if needed
43	E43	HIGH LINE VOLT	Control detects a high power supply voltage condition.	<ul style="list-style-type: none"> High line voltage supply 	<ul style="list-style-type: none"> Verify unit is connected to power supply as specified on rating plate Correct high line voltage condition; Contact local utility if needed
44	E44	OP TEMP RANGE	The control detects the outdoor temperature outside recommended operational range. Unit may continue to operate normally.	<ul style="list-style-type: none"> Ambient air conditions too high or low 	<ul style="list-style-type: none"> Cycle power; re-try during usable ambient temperature range
45	E45	NO COOLING TEST	The control is unable to start the Cooling mode test because indoor heat has been turned on by thermostat. Please set thermostat to off position.	<ul style="list-style-type: none"> Heat provided by secondary heating source 	<ul style="list-style-type: none"> Turn off heater using thermostat before running AHR1 mode
46	E46	NO HEATING TEST	The control is unable to start the Heating mode test because indoor heat has been turned on by thermostat. Please set thermostat to off position.	<ul style="list-style-type: none"> Heat provided by secondary heating source 	<ul style="list-style-type: none"> Turn off heater using thermostat before running AHR1 mode
47	E47	NO SYS VER TEST	The control is unable to start the System Verification test because indoor heat has been turned on by thermostat. Please set thermostat to off position.	<ul style="list-style-type: none"> Heat provided by secondary heating source 	<ul style="list-style-type: none"> Turn off heater using thermostat before operation
48	E48	NO PUMP DOWN	The control is unable to enter the Pump Down Mode because indoor heat has been turned on by thermostat. Please set thermostat to off position.	<ul style="list-style-type: none"> Heat provided by secondary heating source 	<ul style="list-style-type: none"> Turn off heater using thermostat before operation
49	E49	NO CHARGE MODE	The control is unable to enter Charging Mode because indoor heat has been turned on by thermostat. Please set thermostat to off position.	<ul style="list-style-type: none"> Heat provided by secondary heating source 	<ul style="list-style-type: none"> Turn off heater using thermostat before operation
50	E50	LINE VOLT CTRL	This indicates there is a voltage issue on the control board. See service manual for troubleshooting information.	<ul style="list-style-type: none"> High or low voltage from supply Faulty control board 	<ul style="list-style-type: none"> Correct low/high line voltage condition; Contact local utility if needed Replace control board if necessary
51*2	E51	OD COMM ERROR	This indicates potential communication issues have been detected by the outdoor control board.	<ul style="list-style-type: none"> Communication wiring disconnected 	<ul style="list-style-type: none"> Check communication wiring; Repair as needed
52	-	COMP FAIL MINOR	This error indicates the equipment is experiencing frequent compressor faults. Control has determined continued operation is acceptable. This indicates they may be a problem with the equipment.	<ul style="list-style-type: none"> Stop valve not completely open The compressor wire is lost phase Compressor motor failure 	<ul style="list-style-type: none"> Check the opening of stop valve, should be full open; Repair/replace if needed Check the wire between control board and compressor Inspect compressor motor for proper function; Replace if necessary

(*1) This message displayed when using the CTKO4 thermostat.

(*2) This specification of *VZC20*1 or earlier model are different from this specification. For details, see the service manual that matches the major revision of model name.

TROUBLESHOOTING

Fault Code	Control Board LED Display	Transmitted Climate Talk Message	Thermostat Fault	Probable Causes	Corrective Actions
53	-	PCB PR FAN MIN	This error indicates the equipment is experiencing frequent outdoor control board and/or motor faults. Control has determined continued operation is acceptable. This indicates there may be a problem with the equipment.	<ul style="list-style-type: none"> Obstruction in fan rotation Outdoor fan motor not connected properly Outdoor fan not running Faulty control board Noise 	<ul style="list-style-type: none"> Check and clean grille of any debris Check wiring from outdoor fan motor to control board; Repair if needed Check outdoor fan motor & wiring; Repair/replace if needed Replace control board if necessary
54	-	EEV MINOR	This error indicates the equipment is experiencing frequent low discharge superheat faults. Control has determined continued operation is acceptable. This indicates they may be a problem with the equipment.	<ul style="list-style-type: none"> Thermistors inoperable or improperly connected Faulty TXV Faulty control board 	<ul style="list-style-type: none"> Check the connection to thermistors; Repair/replace if needed Check TXV; Replace if needed Replace control board if necessary
55	-	HI DIS TEMP MIN	This error indicates the equipment is experiencing frequent high discharge temperature faults. Control has determined continued operation is acceptable. This indicates they may be a problem with the equipment.	<ul style="list-style-type: none"> Discharge thermistor inoperable or improperly connected Discharge thermistor is put on incorrect position or off Low refrigerant charge Overcharge Faulty compressor 	<ul style="list-style-type: none"> Check discharge thermistor resistance and connections; Repair/replace as needed Check discharge thermistor position Check refrigerant charge level; Adjust if needed Check refrigerant charge level; Adjust if needed Check the compressor; Repair/replace if needed
57	-	CL LOOP SWEAT	This indicates the control is sensing sweating on the cooling loop.	<ul style="list-style-type: none"> Refrigerant Leak Low refrigerant charge Faulty TXV Thermistors inoperable or improperly connection 	<ul style="list-style-type: none"> Test for system leaks using leak test procedure Check refrigerant charge level; Adjust if needed Check TXV; Replace if needed Check the connection to thermistors; Repair/replace if needed
B0	Eb0	NO ID AIRFLOW	The estimated airflow from indoor subsystem is near to 0 CFM.	<ul style="list-style-type: none"> Failed indoor blower motor Indoor fan motor not properly connected Too much static pressure 	<ul style="list-style-type: none"> Check ID fan motor wiring and connectors; Repair/replace if needed Check ID fan motor; Replace if needed
B9	Eb9	LOW ID AIRFLOW	Estimated airflow from motor is lower than the airflow requirement.	<ul style="list-style-type: none"> Failed indoor blower motor Indoor fan motor not properly connected Too much static pressure 	<ul style="list-style-type: none"> Check ID fan motor wiring and connectors; Repair/replace if needed Check ID fan motor; Replace if needed
D0	Ed0	NO NET DATA	Control board does not have the necessary data for it to properly perform its functions.	<ul style="list-style-type: none"> Air conditioner is wired as part of a communicating system and integrated control module does not contain any shared data. 	<ul style="list-style-type: none"> Replace control board if necessary Re-write shared data using Bluetooth® Shared Data Loader BTSDL01
D1	Ed1	INVALID DATA	Control board does not the appropriate data needed to properly perform its functions.	<ul style="list-style-type: none"> Air conditioner is wired as part of a communicating system and integrated control module contains invalid shared data or network data is invalid for the integrated control module. 	<ul style="list-style-type: none"> Replace control board if necessary Re-write shared data using Bluetooth® Shared Data Loader BTSDL01
D2	Ed2	INVALID SYSTEM	The airflow requirement is greater than the airflow capability of the indoor subsystem.	<ul style="list-style-type: none"> Air conditioner/heat pump is wired as part of a communicating system and outdoor unit requires airflow greater than indoor unit's airflow capability Shared data is incompatible the system or missing parameters Communication wiring has loose connection. 	<ul style="list-style-type: none"> Verify shared data is correct for your specific model; Repopulate data if required Check communication wiring. Repair as needed.
D3	Ed3	INVALID CONFIG	There is a mismatch between the shared data and the control physical hardware.	<ul style="list-style-type: none"> Shared data sent to integrated control module does not match hardware configuration. 	<ul style="list-style-type: none"> Verify shared data is correct for your specific model; Repopulate data if required.
D4	Ed4	INVALID MC DATA	The Bluetooth® Shared Data Loader BTSDL01 data has been rejected.	<ul style="list-style-type: none"> Shared data on Bluetooth® Shared Data Loader BTSDL01 has been rejected. 	<ul style="list-style-type: none"> Verify shared data is correct for your specific model; Repopulate data if required.
Items below are messages only displayed on the thermostat screen.					
11	E11	RUN SYS TEST	This test is required at startup. Installer should navigate to the ComfortNet User Menu, choose Air Conditioner, then EQUIP TEST and SYSTEM TEST. Selecting ON will run the required test. Display will clear once testing is complete.	<ul style="list-style-type: none"> Incomplete SYSTEM TEST SYSTEM TEST is running 	MESSAGE ONLY

(*1) This message displayed when using the CTKO4 thermostat.

TROUBLESHOOTING

RE-WRITING SHARED DATA TO OUTDOOR UNIT USING BLUETOOTH® SHARED DATA LOADER BTSDL01

Check Troubleshooting codes to determine the need to flash shared data to outdoor unit. Follow the below procedure to flash shared data.

Procedure to flash shared data to Outdoor unit using Bluetooth® Shared Data Loader BTSDL01

1. Turn the power OFF to the outdoor unit.
2. Disconnect the Climate Talk (CT) connector from the outdoor unit.
3. Insert the Bluetooth® Shared Data Loader BTSDL01 on the outdoor unit.
4. Turn the power ON to the outdoor unit.
5. Verify that H1P (red LED) flashes twice. This step confirms that the data has been transferred from the Bluetooth® Shared Data Loader BTSDL01 to the outdoor unit.
6. Turn the power OFF to the outdoor unit.
7. Remove the Bluetooth® Shared Data Loader BTSDL01 from the unit.

8. Connect the Climate Talk (CT) connector to the outdoor unit.
9. Turn the power ON to the outdoor unit.
10. Continue the operation of the unit as desired.

NOTE:

1. If there is an error E11 on the 7-segment display of the Outdoor unit after step 11, run the System Verification Test on the Outdoor unit using the thermostat menu.
 - AC - Menu → Air Conditioner → Equip Test → System Verification Test → ON
 - HP - Menu → Heat Pump → Equip Test → System Verification Test → ON
2. The control boards for different 20 SEER OD units (2T, 3T, 4T, 5T) are different. Below are the names of the connectors for quick identification.
 - Bluetooth® Shared Data Loader BTSDL01 connector - X52A (white - 12 pin connector)
 - Climate Talk connector - X851A (green - 9 pin connector)
 - Red LED - H1P



IDENTIFICATION OF CONNECTORS ON 20 SEER OD CONTROL BOARD

TROUBLESHOOTING

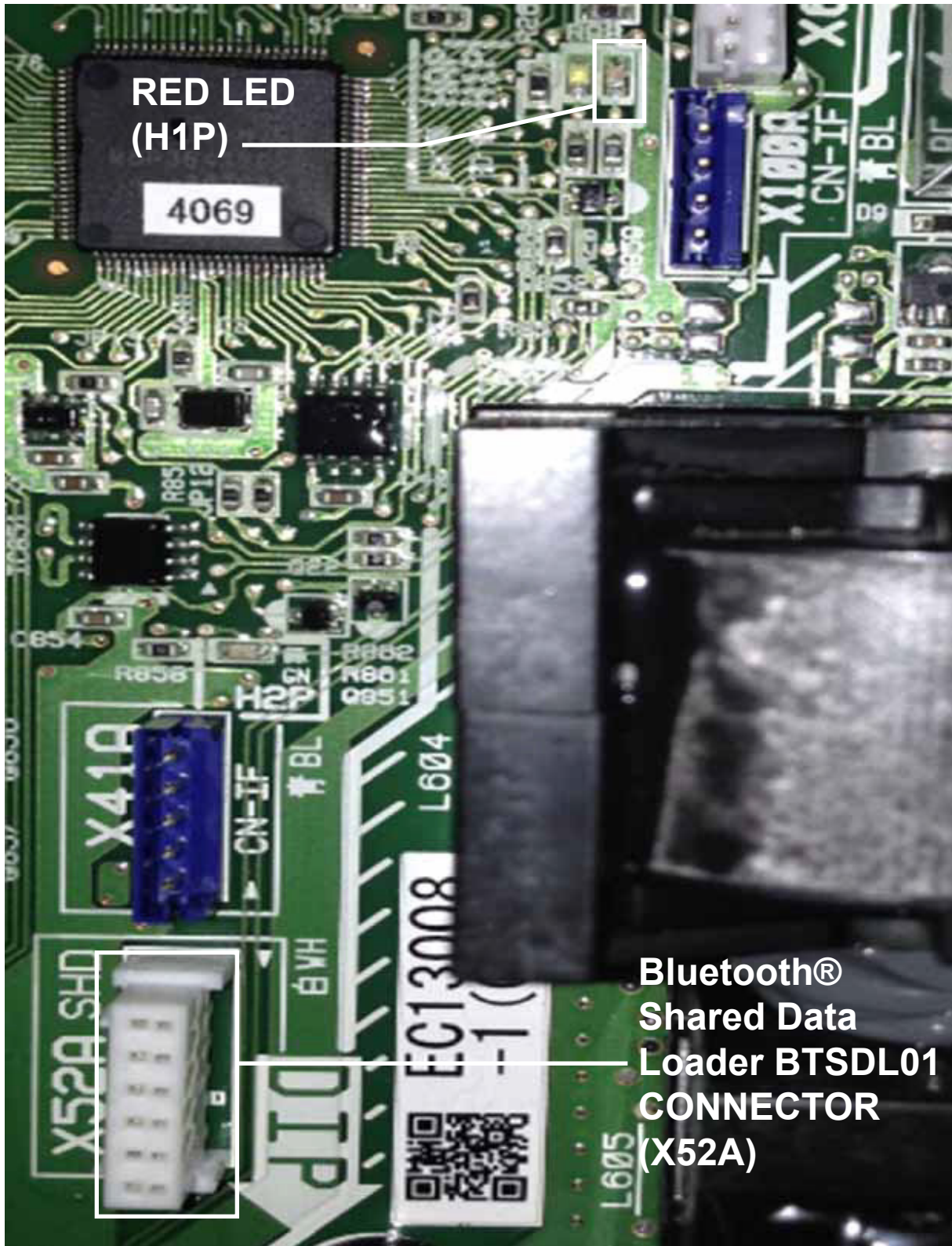

**RED LED
(H1P)**

**Bluetooth®
Shared Data
Loader BTSDL01
CONNECTOR
(X52A)**

ZOOMED VIEW OF 20 SEER OD CONTROL BOARD

TROUBLESHOOTING

NETWORK TROUBLESHOOTING

If a network communication error code has occurred, use the following steps to help troubleshoot the system. (For network communication error codes, refer to the table below and the tables of error codes for outdoor unit and indoor unit.)

After any wiring changes have been made or DS1 dip switches on the outdoor unit control board have been changed, apply power to the system and see if the error codes have cleared.

1. Confirm low voltage wiring is correct per installation instructions. Check for miswiring. (i.e. Terminal 1 and 2 is reversed.)

NOTE: A removable plug connector is provided with the control to make thermostat wire connections. This plug may be removed, wire connections made to the plug, and replaced. It is strongly recommended that you do not connect more than two wires into a single terminal in the field because there is a risk of the wires becoming loose, which may result in intermittent operation.

2. Check wires for damage. (i.e. Broken wire at terminal, broken inside wire nuts or damaged cable between units.)

3. Perform continuity check on wires to make sure cable is OK. Replace the cable if necessary.
4. Change both dip switches of DS1 on the outdoor unit control board to the opposite position. See image above.

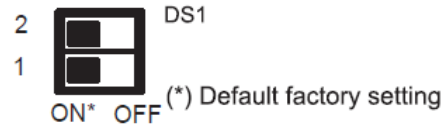

The integrated control module has some onboard tools that can be used to troubleshoot the network. These tools are: red communications LED, green receive (Rx) LED, and the learn button.

- Red communications LED – Indicates the status of the network. The table below indicates the LED status and the corresponding potential problem.
- Green receive LED – Indicates network traffic. The table below indicates the LED status and the corresponding potential problem.
- LEARN button – Used to reset the network. Press the button for approximately 5 seconds to reset the network.

LED COLOR	LED Status	Indication	Probable Causes	Corrective Actions
Red Communications LED Outdoor unit control board: (H1P) Indoor unit control board: (H2P)	Off	Normal condition	• None	• None
	1 Flash	Communications failure	• Unknown packet is received • Communications failure	• Depress learn button • Verify wiring connection
	2 Flash	Out-of-box reset	• Control power up • Learn button depressed	• None
Green Receive LED Outdoor unit control board: (H2P) Indoor unit control board: (H3P)	Off	No power Communications error	• No power to unit • Open fuse • Communication error	• Check circuit breakers and fuses; Reset/Replace if needed • Reset network by depressing learn button • Check communication wires (terminal 1/terminal 2 wires); Replace if needed • Check for shorts in low voltage wiring.
	1 Steady Flash	No network found	• Broken/disconnected communication wire(s) • Unit is installed as a legacy/traditional system	• Check communication wires (terminal 1/terminal 2 wires); Replace if needed • Check installation type (legacy/traditional or communicating)
	Rapid Flashing	Normal network traffic	• Control is "talking" on network as expected	• None
	On Solid	Terminal 1/Terminal 2 miss-wire	• Terminal 1 and Terminal 2 wires reversed at indoor unit, thermostat, or outdoor unit • Short between terminal 1 and terminal 2 wires • Short between terminal 1 or terminal 2 two wires and terminal C (24VAC) or terminal R (24VAC, COM)	• Check communication wires (terminal 1/terminal 2 wires); Replace if needed

TROUBLESHOOTING

THERMISTOR RESISTANCE VALUE

		Tm : Coil Tl : Liquid Tb : Defrost Tgi: Indoor Gas Tli: Indoor Liquid		Tl : Liquid		Td : Discharge		Ta : Ambient	
TEMP	TEMP	Thermistor Resistance	Volts	Thermistor Resistance	Volts	Thermistor Resistance	Volts	Thermistor Resistance	Volts
(°C)	(F)	R (kΩ)	DC (V)	R (kΩ)	DC (V)	R (kΩ)	DC (V)	R (kΩ)	DC (V)
-30	-22	364.43	4.58	364.43	4.58	4759.15	4.96	362.48	4.58
-25	-13	267.00	4.45	267.00	4.45	3454.24	4.94	265.99	4.45
-20	-4	197.81	4.29	197.81	4.29	2533.62	4.92	197.31	4.28
-15	5	148.10	4.09	148.10	4.09	1877.01	4.90	147.86	4.09
-10	14	111.99	3.86	111.99	3.86	1403.82	4.86	111.88	3.86
-5	23	85.49	3.61	85.49	3.61	1059.45	4.82	85.43	3.61
0	32	65.84	3.33	65.84	3.33	806.47	4.77	65.80	3.33
5	41	51.09	3.04	51.09	3.04	618.95	4.70	51.10	3.04
10	50	39.96	2.74	39.96	2.74	478.76	4.62	39.99	2.74
15	59	31.50	2.44	31.50	2.44	373.11	4.53	31.54	2.44
20	68	25.01	2.16	25.01	2.16	292.86	4.41	25.06	2.16
25	77	20.00	1.89	20.00	1.89	231.44	4.28	20.04	1.89
30	86	16.10	1.64	16.10	1.64	184.11	4.13	16.13	1.64
35	95	13.04	1.42	13.04	1.42	147.37	3.95	13.07	1.42
40	104	10.63	1.22	10.63	1.22	118.68	3.76	10.65	1.22
45	113	8.71	1.04	8.71	1.04	96.13	3.56	8.73	1.05
50	122	7.18	0.89	7.18	0.89	78.29	3.34	7.18	0.89
55	131	5.95	0.76	5.95	0.76	64.10	3.11	-	-
60	140	4.96	0.65	4.96	0.65	52.76	2.87	-	-
65	149	4.16	0.56	4.16	0.56	43.63	2.64	-	-
70	158	3.50	0.48	3.50	0.48	36.26	2.41	-	-
75	167	2.96	0.41	2.96	0.41	30.27	2.18	-	-
80	176	2.51	0.35	2.51	0.35	25.38	1.97	-	-
85	185	2.14	0.30	2.14	0.30	21.37	1.77	-	-
90	194	1.83	0.26	1.83	0.26	18.06	1.58	-	-
95	203	1.58	0.23	1.58	0.23	15.33	1.41	-	-
100	212	1.36	0.20	1.36	0.20	13.06	1.25	-	-
105	221	1.18	0.17	1.18	0.17	11.17	1.11	-	-
110	230	1.02	0.15	1.02	0.15	9.59	0.99	-	-
115	239	0.89	0.13	0.89	0.13	8.25	0.87	-	-
120	248	0.78	0.12	0.78	0.12	7.13	0.77	-	-
125	257	0.68	0.10	0.68	0.10	6.18	0.68	-	-
130	266	0.60	0.09	0.60	0.09	5.37	0.61	-	-
135	275	0.53	0.08	0.53	0.08	4.69	0.54	-	-
140	284	0.47	0.07	0.47	0.07	4.10	0.48	-	-
145	293	0.42	0.06	0.42	0.06	3.59	0.42	-	-
150	302	0.37	0.06	0.37	0.06	3.16	0.37	-	-

R-410A Pressure vs. Temperature Chart

PSIG	°F	PSIG	°F	PSIG	°F	PSIG	°F	PSIG	°F	PSIG	°F
12	-37.7	114	37.8	216	74.3	318	100.2	420.0	120.7	522	137.6
14	-34.7	116	38.7	218	74.9	320	100.7	422.0	121.0	524	137.9
16	-32.0	118	39.5	220	75.5	322	101.1	424.0	121.4	526	138.3
18	-29.4	120	40.5	222	76.1	324	101.6	426.0	121.7	528	138.6
20	-36.9	122	41.3	224	76.7	326	102.0	428.0	122.1	530	138.9
22	-24.5	124	42.2	226	77.2	328	102.4	430.0	122.5	532	139.2
24	-22.2	126	43.0	228	77.8	330	102.9	432.0	122.8	534	139.5
26	-20.0	128	43.8	230	78.4	332	103.3	434.0	123.2	536	139.8
28	-17.9	130	44.7	232	78.9	334	103.7	436.0	123.5	538	140.1
30	-15.8	132	45.5	234	79.5	336	104.2	438.0	123.9	540	140.4
32	-13.8	134	46.3	236	80.0	338	104.6	440.0	124.2	544	141.0
34	-11.9	136	47.1	238	80.6	340	105.1	442.0	124.6	548	141.6
36	-10.1	138	47.9	240	81.1	342	105.4	444.0	124.9	552	142.1
38	-8.3	140	48.7	242	81.6	344	105.8	446.0	125.3	556	142.7
40	-6.5	142	49.5	244	82.2	346	106.3	448.0	125.6	560	143.3
42	-4.5	144	50.3	246	82.7	348	106.6	450.0	126.0	564	143.9
44	-3.2	146	51.1	248	83.3	350	107.1	452.0	126.3	568	144.5
46	-1.6	148	51.8	250	83.8	352	107.5	454.0	126.6	572	145.0
48	0.0	150	52.5	252	84.3	354	107.9	456.0	127.0	576	145.6
50	1.5	152	53.3	254	84.8	356	108.3	458.0	127.3	580	146.2
52	3.0	154	54.0	256	85.4	358	108.8	460.0	127.7	584	146.7
54	4.5	156	54.8	258	85.9	360	109.2	462.0	128.0	588	147.3
56	5.9	158	55.5	260	86.4	362	109.6	464.0	128.3	592	147.9
58	7.3	160	56.2	262	86.9	364	110.0	466.0	128.7	596	148.4
60	8.6	162	57.0	264	87.4	366	110.4	468.0	129.0	600	149.0
62	10.0	164	57.7	266	87.9	368	110.8	470.0	129.3	604	149.5
64	11.3	166	58.4	268	88.4	370	111.2	472.0	129.7	608	150.1
66	12.6	168	59.0	270	88.9	372	111.6	474.0	130.0	612	150.6
68	13.8	170	59.8	272	89.4	374	112.0	476.0	130.3	616	151.2
70	15.1	172	60.5	274	89.9	376	112.4	478.0	130.7	620	151.7
72	16.3	174	61.1	276	90.4	378	112.6	480.0	131.0	624	152.3
74	17.5	176	61.8	278	90.9	380	113.1	482.0	131.3	628	152.8
76	18.7	178	62.5	280	91.4	382	113.5	484.0	131.6	632	153.4
78	19.8	180	63.1	282	91.9	384	113.9	486.0	132.0	636	153.9
80	21.0	182	63.8	284	92.4	386	114.3	488.0	132.3	640	154.5
82	22.1	184	64.5	286	92.8	388	114.7	490.0	132.6	644	155.0
84	23.2	186	65.1	288	93.3	390	115.0	492.0	132.9	648	155.5
86	24.3	188	65.8	290	93.8	392	115.5	494.0	133.3	652	156.1
88	25.4	190	66.4	292	94.3	394	115.8	496.0	133.6	656	156.6
90	26.4	192	67.0	294	94.8	396	116.2	498.0	133.9	660	157.1
92	27.4	194	67.7	296	95.2	398	116.6	500.0	134.0	664	157.7
94	28.5	196	68.3	298	95.7	400	117.0	502.0	134.5	668	158.2
96	29.5	198	68.9	300	96.2	402	117.3	504.0	134.8	672	158.7
98	30.5	200	69.5	302	96.6	404	117.7	506.0	135.2	676	159.2
100	31.2	202	70.1	304	97.1	406	118.1	508.0	135.5	680	159.8
102	32.2	204	70.7	306	97.5	408	118.5	510.0	135.8	684	160.3
104	33.2	206	71.4	308	98.0	410	118.8	512.0	136.1	688	160.8
106	34.1	208	72.0	310	98.4	412	119.2	514.0	136.4	692	161.3
108	35.1	210	72.6	312	98.9	414	119.6	516.0	136.7	696	161.8
110	35.5	212	73.2	314	99.3	416	119.9	518.0	137.0		
112	36.9	214	73.8	316	99.7	418	120.3	520.0	137.3		

TROUBLESHOOTING

Required Liquid Line Temperature						
LIQUID PRESSURE AT SERVICE VALVE (PSIG)	REQUIRED SUBCOOLING TEMPERATURE (°F)					
	8	10	12	14	16	18
189	58	56	54	52	50	48
195	60	58	56	54	52	50
202	62	60	58	56	54	52
208	64	62	60	58	56	54
215	66	64	62	60	58	56
222	68	66	64	62	60	58
229	70	68	66	64	62	60
236	72	70	68	66	64	62
243	74	72	70	68	66	64
251	76	74	72	70	68	66
259	78	76	74	72	70	68
266	80	78	76	74	72	70
274	82	80	78	76	74	72
283	84	82	80	78	76	74
291	86	84	82	80	78	76
299	88	86	84	82	80	78
308	90	88	86	84	82	80
317	92	90	88	86	84	82
326	94	92	90	88	86	84
335	96	94	92	90	88	86
345	98	96	94	92	90	88
354	100	98	96	94	92	90
364	102	100	98	96	94	92
374	104	102	100	98	96	94
384	106	104	102	100	98	96
395	108	106	104	102	100	98
406	110	108	106	104	102	100
416	112	110	108	106	104	102
427	114	112	110	108	106	104
439	116	114	112	110	108	106
450	118	116	114	112	110	108
462	120	118	116	114	112	110
474	122	120	118	116	114	112
486	124	122	120	118	116	114
499	126	124	122	120	118	116
511	128	126	124	122	120	118

TROUBLESHOOTING

⚠ WARNING

HIGH VOLTAGE !

DISCONNECT ALL POWER BEFORE SERVICING OR INSTALLING. MULTIPLE POWER SOURCES MAY BE PRESENT. FAILURE TO DO SO MAY CAUSE PROPERTY DAMAGE, PERSONAL INJURY OR DEATH.



⚠ CAUTION

WHEN REPLACING THE ELECTRICAL BOARD, DO NOT TOUCH THE HATCHED AREAS. BEFORE INSTALLING THE NEW ELECTRICAL BOARD, BE SURE TO WIPE THE GREASE OFF THE REFRIGERANT TUBING. EXERCISE CAUTION TO NOT DAMAGE THE ELECTRICAL CONNECTIONS. DISCONNECT AS NEEDED.

UNINSTALL THE ELECTRICAL BOARD

When uninstalling the main electrical board, remove the screws holding the cover in place. If board replacement is attempted without following proper uninstallation procedure, the refrigerant piping might be damaged. Always replace the grease with new grease on heat sink used for cooling. Not replacing grease may result in insufficient cooling and may damage the electrical board.

1. Remove the fixing screw A.
2. Lift the cover and open it in the direction shown in the figure.
3. Remove fixing screws B affixing the sheet metal plate.
4. Carefully slide the sheet metal plate with the electrical board behind the refrigerant tubing as shown.

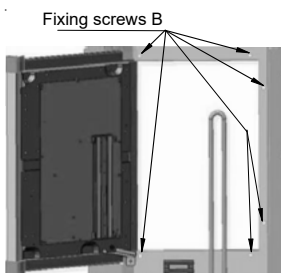
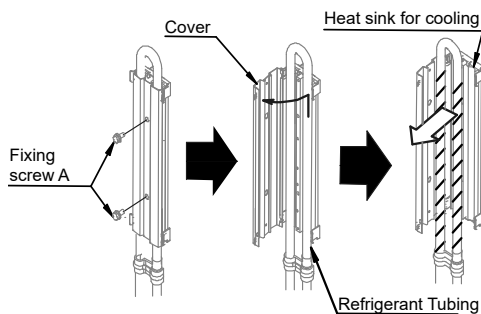

INSTALL THE ELECTRICAL BOARD

When working on a service port, ensure that no refrigerant and/or compressor oil is sprayed onto the electrical board. This could damage the board's functionality.

1. Wipe the stale grease completely from the installed piping. If you reinstall the control board, make sure to wipe clean the heat sink on the board. Coat the surface with the standard quantity of the specified new grease.
2. Carefully slide the sheet metal plate back in and fix the screws B.
3. Do not apply force to the parts on the control board. Hold the control board plate NOT the control board.
4. Ensure that the liquid tube does not come in contact with any part of the PCB assembly.
5. Gently fit the tube in the heat sink troughs. Ensure good contact.
6. Close the cover, slide it downwards, fix it with the nails (two nails) and tighten fixing screws A so that the piping is tightly connected.

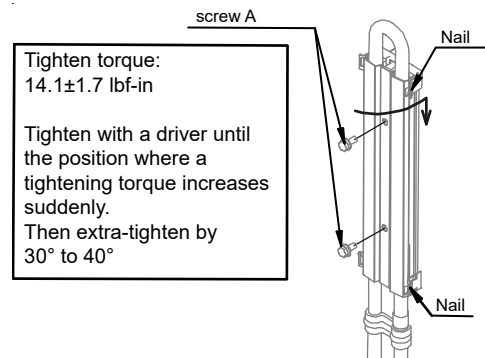
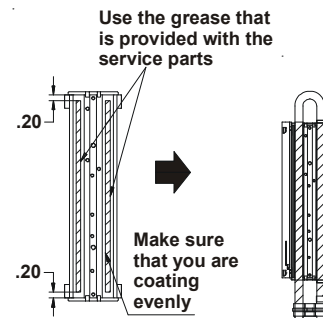

TROUBLESHOOTING

⚠ WARNING

AVOID CONTACT WITH THE CHARGED AREA.

• NEVER TOUCH THE CHARGED AREA BEFORE CONFIRMING THAT THE RESIDUAL VOLTAGE IS 50 VOLTS OR LESS.

1. SHUT DOWN THE POWER AND LEAVE THE CONTROL BOX FOR 10 MINUTES.
2. MAKE SURE TO TOUCH THE EARTH GROUND TERMINAL TO RELEASE THE STATIC ELECTRICITY FROM YOUR BODY (TO PREVENT FAILURE OF THE PCB).
3. MEASURE THE RESIDUAL VOLTAGE IN THE SPECIFIED MEASUREMENT POSITION USING A VOM WHILE PAYING ATTENTION NOT TO TOUCH THE CHARGED AREA.
4. IMMEDIATELY AFTER MEASURING THE RESIDUAL VOLTAGE, DISCONNECT THE CONNECTORS OF THE OUTDOOR UNIT'S FAN MOTOR. (IF THE FAN BLADE ROTATES BY STRONG WIND BLOWING AGAINST IT, THE CAPACITOR WILL BE CHARGED, CAUSING THE DANGER OF ELECTRICAL SHOCK.)

*VZC200361**

*VZC200481**

*VZC200601**

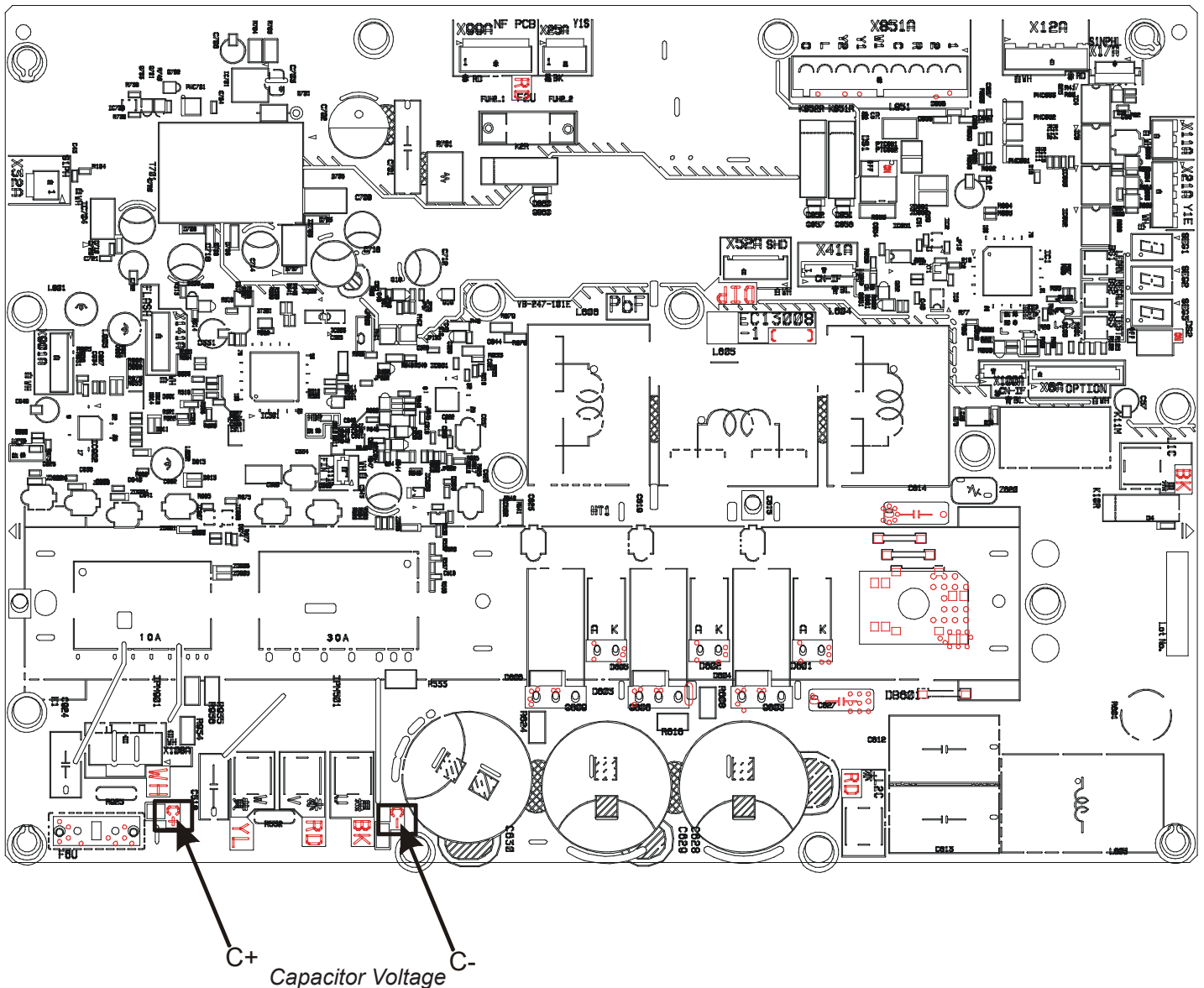

WIRING DIAGRAM

***VZC200481** / *VZC200601B* (OR LATER)**



WARNING
HIGH VOLTAGE!
 DISCONNECT ALL POWER BEFORE SERVICING OR INSTALLING THIS UNIT.
 MULTIPLE POWER SOURCES MAY BE PRESENT. FAILURE TO DO SO MAY
 CAUSE PROPERTY DAMAGE, PERSONAL INJURY OR DEATH.

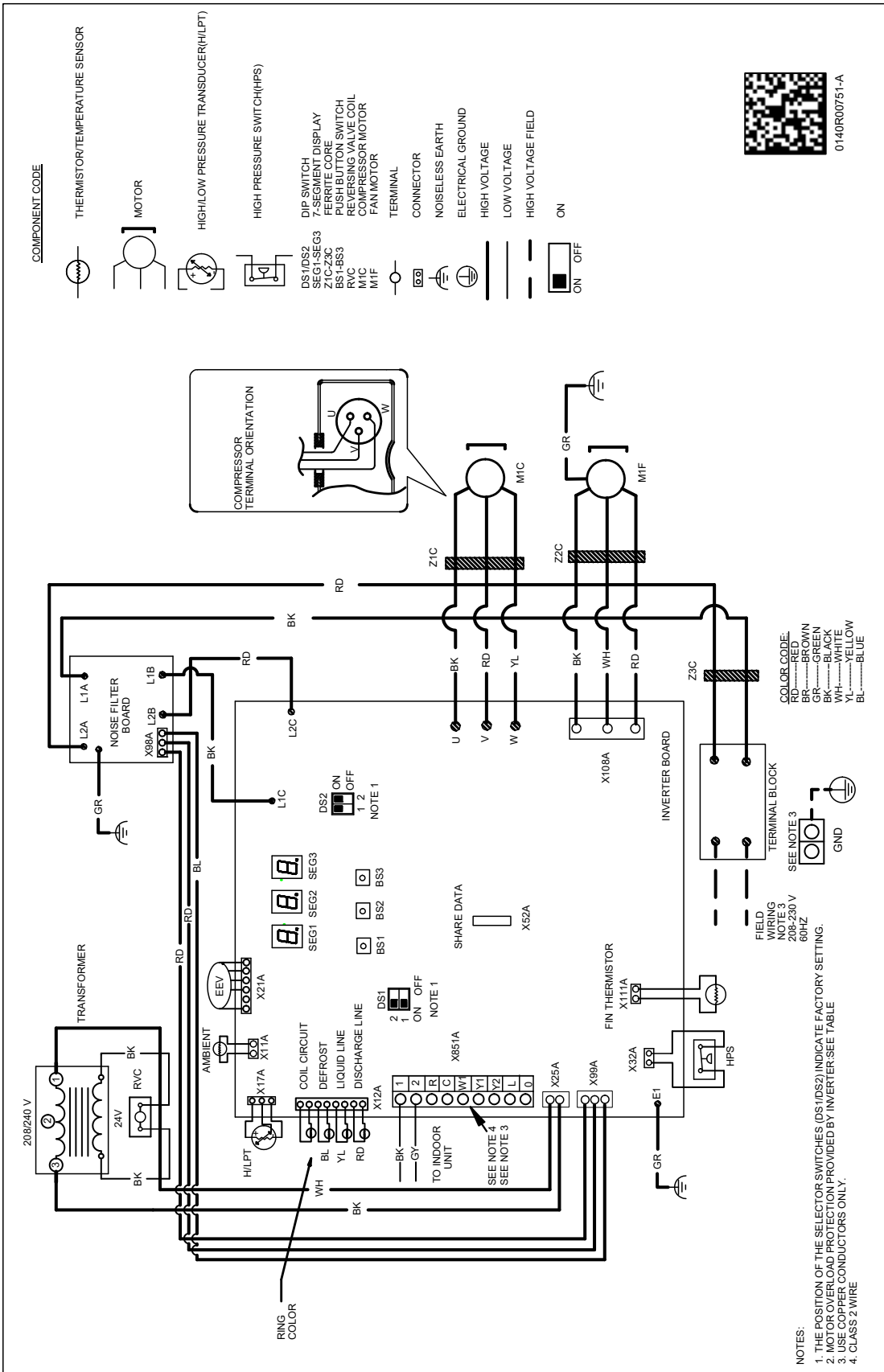

COMPONENT CODE

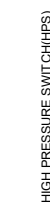
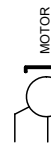

- DS1/DS2
- ZIC
- Z1C
- Z2C
- BS1-BS3
- M1C
- M1F
- TERMINAL
- CONNECTOR
- NOISELESS EARTH
- ELECTRICAL GROUND
- HIGH VOLTAGE
- LOW VOLTAGE
- HIGH VOLTAGE FIELD
- ON
- OFF



0140R00751-A

- COLOR CODE:
- RD.....RED
 - WH.....WHITE
 - GR.....GREEN
 - BK.....BLACK
 - WH.....WHITE
 - YL.....YELLOW
 - BL.....BLUE

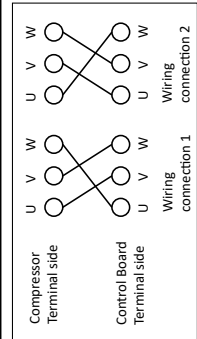

NOTE: The compressor can operate normally in any of the following wiring connections shown on the right.
 (Wiring connection between control board and compressor terminal)

Wiring is subject to change. Always refer to wiring diagram on the unit for the most up to date wiring.

WIRING DIAGRAM



WARNING

HIGH VOLTAGE!
DISCONNECT ALL POWER BEFORE SERVICING OR INSTALLING THIS UNIT.
MULTIPLE POWER SOURCES MAY BE PRESENT. FAILURE TO DO SO MAY CAUSE PROPERTY DAMAGE, PERSONAL INJURY OR DEATH.



INDOOR UNIT FOR TXV APPLICABLE UNIT (MBVC**00AA-A)

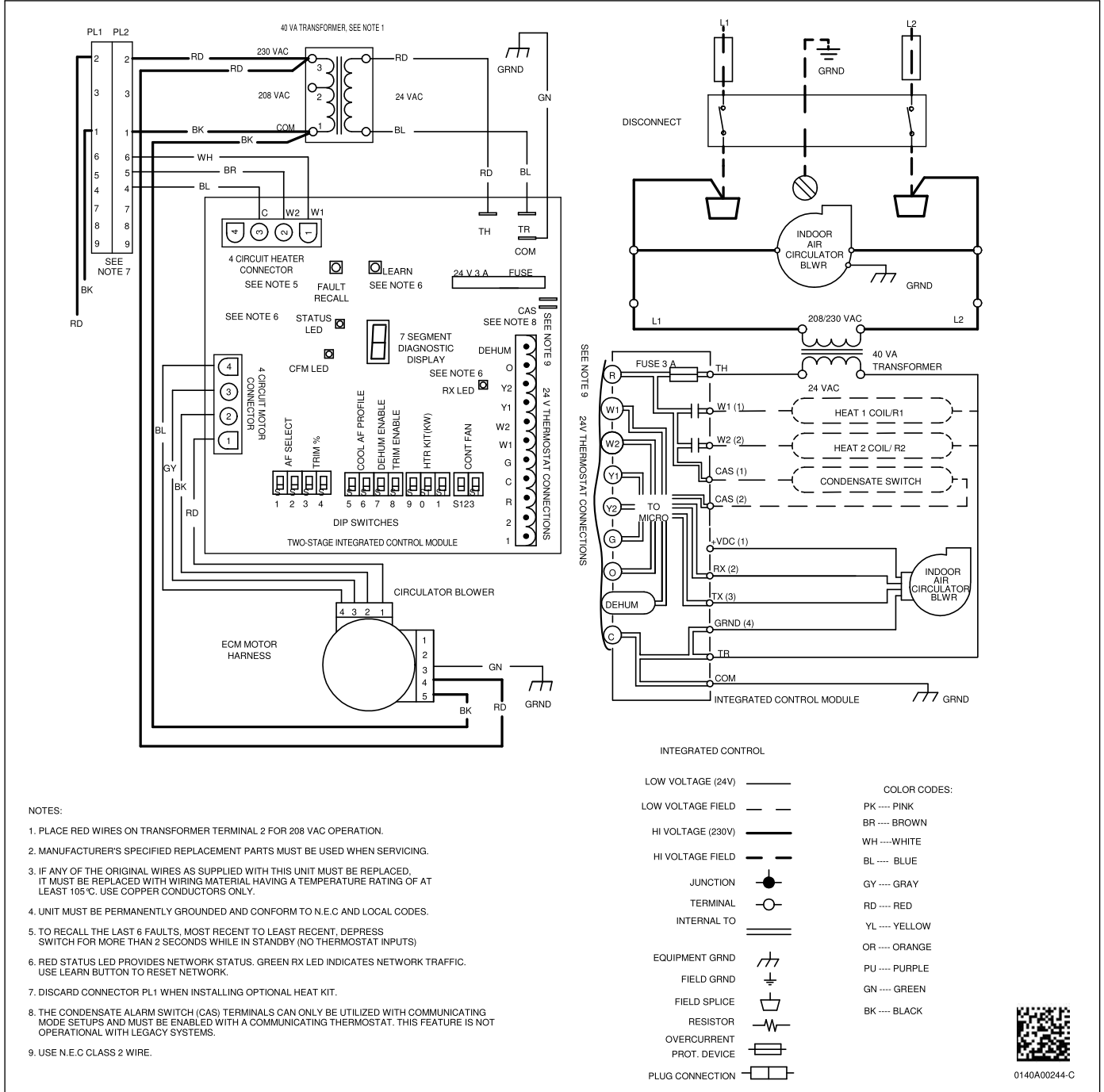

ACCESSORIES EXPANSION VALVES

VZC201****

Model Name	TXV-Kit
*VZC200241**	TXV-V24
*VZC200361**	TXV-V36
*VZC200481**	TXV-V48
*VZC200601**	TXV-V60

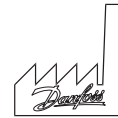
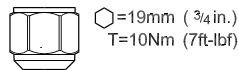
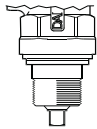
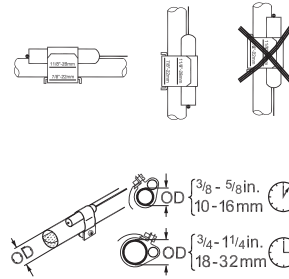
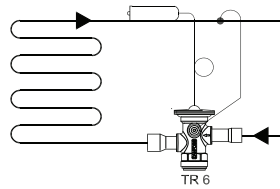
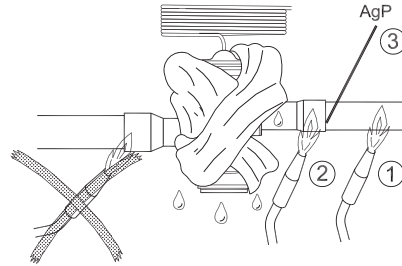
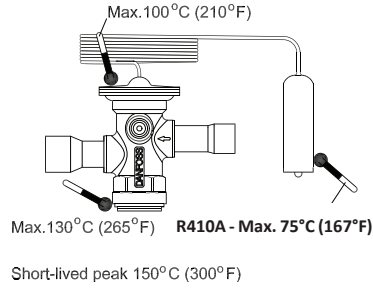

SS = 2°C (3.6°F) or according to customer specification

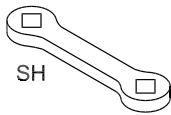

⊕ ⊖
ΔSH/360° ≈ R410A: 0.6°C / turn - 1.1°F / turn

	Number of turns from SS to TIGHT Spring ⊕	Number of turns from SS to LOOSE Spring ⊖
R410A	+9.5	-2

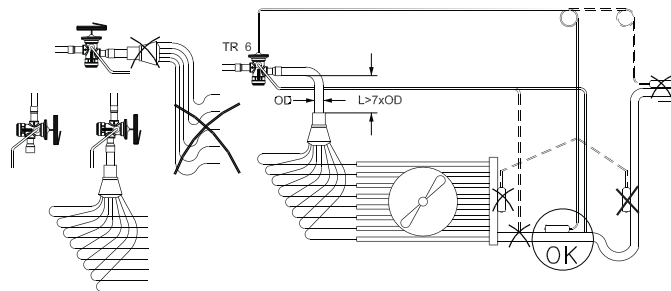

ACCESSORIES

ELECTRIC HEATER (OPTIONAL ITEM)

Optional electric heaters may be added, in the quantities shown in the specifications section, to provide electric resistance heating.

Under no condition shall more heaters than the quantity shown be installed.

The low voltage circuit in the air handler is factory wired and terminates at the location provided for the electric heater(s).

A minimum of field wiring is required to complete the installation.

Other components such as a Heating/Cooling Thermostat and Outdoor Thermostats are available to complete the installation.

HEATER KIT CAPACITY SETTING (AVPEC*):

For heater kit installation, it is important to set the capacity of the electric heater at the communicating thermostat and DIP switch.

SETTING WITH COMMUNICATING THERMOSTAT:

For a detailed procedure of thermostat heater kit capacity selection process, please refer the Set-Up section of CTK04 ADDENDUM in this manual.

SETTING WITH DIP SWITCH:

In the event of loss of communication, emergency mode can be activated. In emergency mode operation, heater kit selection will be driven by the DIP switch (S9, S10, S11 and S12) selection from the control board on indoor unit.

For further detail, read an emergency mode section in this manual.

The heating mode temperature rise is dependent upon the system airflow, the supply voltage, and the heater kit size (kW) selected. Use data provided in below Tables to determine the temperature rise (°F).

CFM	HEAT KIT NOMINAL kW							
	3	5	6	8	10	15	19/20	25
800	12	19	23	31	37			
1000	9	15	19	25	30	44		
1200	8	12	15	21	25	37	49	62
1400	7	11	13	18	21	32	42	53
1600	6	9	12	15	19	28	37	46
1800	5	8	10	14	16	25	33	41
2000	5	7	9	12	15	22	30	37

240/1/60 SUPPLY VOLTAGE - TEMP. RISE °F

CFM	HEAT KIT NOMINAL kW							
	3	5	6	8	10	15	19/20	25
800	11	18	22	30	35			
1000	9	14	18	24	28	42		
1200	7	12	15	20	24	35	47	59
1400	6	10	13	17	20	30	40	51
1600	6	9	11	15	18	27	35	44
1800	5	8	10	13	16	24	31	39
2000	4	7	9	12	14	21	28	35

230/1/60 SUPPLY VOLTAGE - TEMP. RISE °F

CFM	HEAT KIT NOMINAL kW							
	3	5	6	8	10	15	19/20	25
800	10	17	21	28	33			
1000	8	13	17	22	27	40		
1200	7	11	14	19	22	33	45	56
1400	6	10	12	16	19	29	38	48
1600	5	8	10	14	17	25	33	42
1800	5	7	9	12	15	22	30	37
2000	4	7	8	11	13	20	27	33

220/1/60 SUPPLY VOLTAGE - TEMP. RISE °F

Model	HEATER(kW)								
	3	5	6	8	10	15	19	20	25
AVPEC25B14*	550	650	700	715	875				
AVPEC37C14*		850	900	1000	1120	1220	1250		
AVPEC59D14*		990	1110	1200	1240	1520		1520	
AVPEC61D14*		1030	1150	1250	1320	1650		1690	1715

ELECTRIC HEATER CAPACITY BTUH									
HTR KW	3.0 KW	4.7 KW	6.0 KW	7.0 KW	9.5 KW	14.2 KW	19.5 KW	21.0 KW	
BTUH	10200	16200	20400	23800	32400	48600	66500	71600	

ACCESSORIES

AV**PEC

HEATER KIT

MODELS	HKX03XC	HKX05XC	HKX06XC	HKX08XC	HKX10XC	HKC05XC	HKC08XC	HKC10XC	HKC15XA	HKC15XB	HKC15XF	HKC19CA	HKC19CB	HKC20DH	HKC20DB	HKC20XF	HKC25DA	HKC25DB
AVPEC25B14A*	X	X	X	X	X	X	X	X										
AVPEC37C14A*		X	X	X	X	X	X	X	X	X	X	X	X					
AVPEC59D14A*		X	X	X	X	X	X	X		X	X			X	X			
AVPEC61D14A*		X	X	X	X	X	X	X		X	X			X	X	X	X	X

*Revision level taht may or may not be designated.

NOTE: Airflow selection should meet the minimum requirements as mentioned in the air handler Installation instructions.

For heater kit installation, it is important to set the capacity of the electric heater at Set-up menu on the thermostat and DIP switch on indoor unit control board. For more information, please see indoor unit I/O manual.

ELECTRIC HEAT AIRFLOW TABLE							
Htr kW	9	10	11	AVPEC25B14**	AVPEC37C14+	AVPEC59D14*++	AVPEC61D14++
3	ON	ON	ON	730	850**	NR	NR
5	ON	ON	OFF	780	1250	1250	1250
6	ON	OFF	ON	850	1300	1300	1300
8	ON	OFF	OFF	950	1500	1500	1500
10	OFF	ON	ON	1025	1550	1550	1550
15	OFF	ON	OFF	NR	1720	1720	1780
19*	OFF	OFF	ON	NR	NR	NR	NR
20				NR	1800	1815	1850
21 or 25*	OFF	OFF	OFF	NR	NR	1850	1850

NOTE: Airflow data shown applies to the electric heat only in either legacy mode or communicating mode operation.

* Within thermostat user menu, CTk04 communicating thermostat will display 20 kW for OFF-OFF-ON dip switch selection and 21 kW for OFF- OFF-OFF dip switch selection.

NR- Not rated

+For match up with a 2 ton outdoor unit: Heater kit application shall not exceed 10 kW.

Airflow for 5 kW up to 10 kW heater kits shall be set to 850 cfm speed tap of ON-ON-ON.

++For match up with a 3 ton outdoor unit: Heater kit application shall not exceed 15 kW.

Airflow for 5 kW up to 15 kW heater kits shall be set to 1300 cfm speed tap of ON-OFF-ON.

Airflow for 5 kW up to 20 kW heater kits shall be set to 1500 cfm speed tap of ON-OFF-OFF

** 3 kW heater kit is not applicable for this indoor application.

ACCESSORIES

For installations not indicated above the following formula is to be used:

$$TR = (kW \times 3412) \times (\text{Voltage Correction}) / (1.08 \times \text{CFM})$$

Where: TR = Temperature Rise

kW = Heater Kit Actual kW

3412 = Btu per kW

VC* = 1.0 (240 Supply Volts)

= 0.92 (230 Supply Volts)

= 0.84 (220 Supply Volts)

= 0.77 (210 Supply Volts)

= 0.75 (208 Supply Volts)



1.08 = Constant

CFM = Measured Airflow

*VC (Voltage Correction)

CHECKING HEATER LIMIT CONTROL(S)

Each individual heater element is protected with a limit control device connected in series with each element to prevent overheating of components in case of low airflow. This limit control will open its circuit at approximately 150°F to 160°F and close at approximately 110°F.

**WARNING**
HIGH VOLTAGE!
Disconnect ALL power before servicing or installing. Multiple power sources may be present. Failure to do so may cause property damage, personal injury or death.

1. Remove the wiring from the control terminals.
2. Using an ohmmeter, test for continuity across the normally closed contacts. No reading indicates the control is open - replace if necessary.

IF FOUND OPEN - REPLACE - DO NOT WIRE AROUND.

CHECKING HEATER FUSE LINK (OPTIONAL ELECTRIC HEATERS)

Each individual heater element is protected with a one time fuse link which is connected in series with the element. The fuse link will open at approximately 333°.

**WARNING**
Disconnect ALL power before servicing.

1. Remove heater element assembly so as to expose fuse link.
2. Using an ohmmeter, test across the fuse link for continuity - no reading indicates the link is open. Replace as necessary.

NOTE: The link is designed to open at approximately 333°F. DO NOT WIRE AROUND - determine reason for failure.

CUSTOMER FEEDBACK

We are very interested in all product comments.

Please fill out the feedback form on one of the following links:

Goodman® Brand Products: (<http://www.goodmanmfg.com/about/contact-us>).

Amana® Brand Products: (<http://www.amana-hac.com/about-us/contact-us>).

You can also scan the QR code on the right for the product brand you purchased to be directed to the feedback page.



GOODMAN® BRAND



AMANA® BRAND

Amana is a registered trademark of Maytag Corporation or its related companies and is used under license.

All rights reserved.

Copyright © 2015-2017, 2020-2021 Goodman Manufacturing Company, L.P.